

Engineering Center

Floor Plans

Updated 11/08/2012

Engineering Administrative Wing (ECAD)

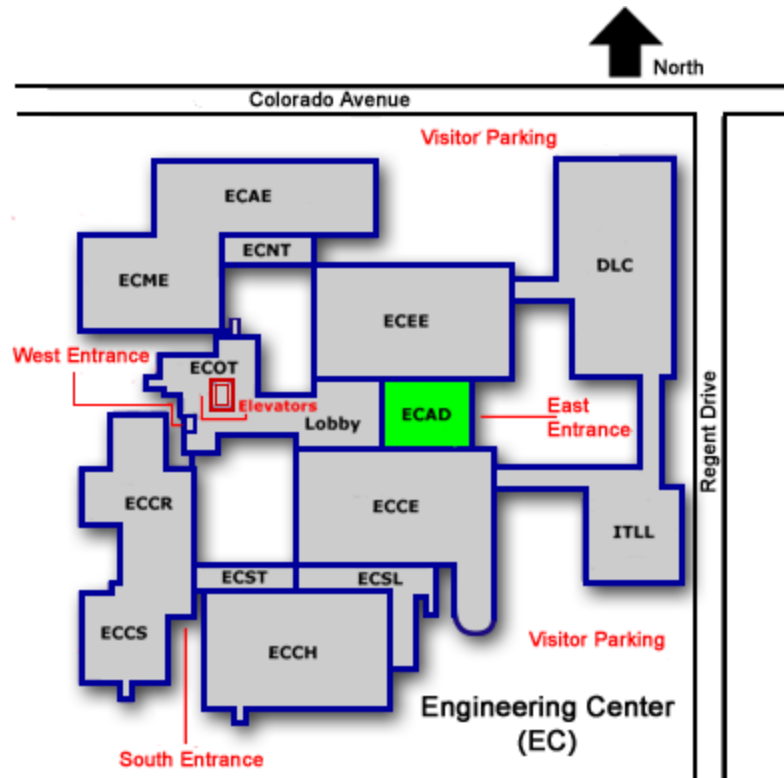

Office Tower (ECOT)

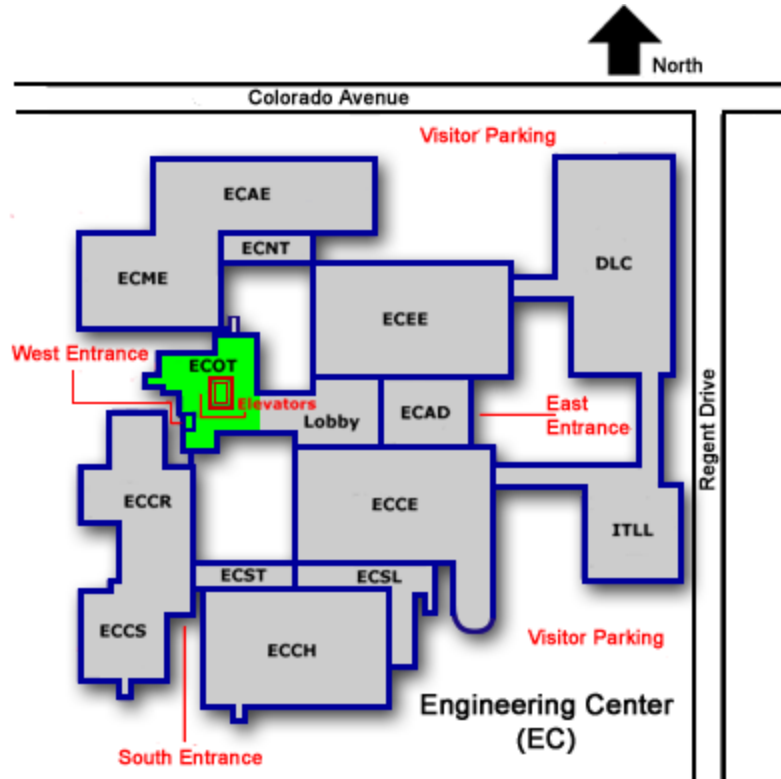

Engineering Center
Office Tower
1st Floor

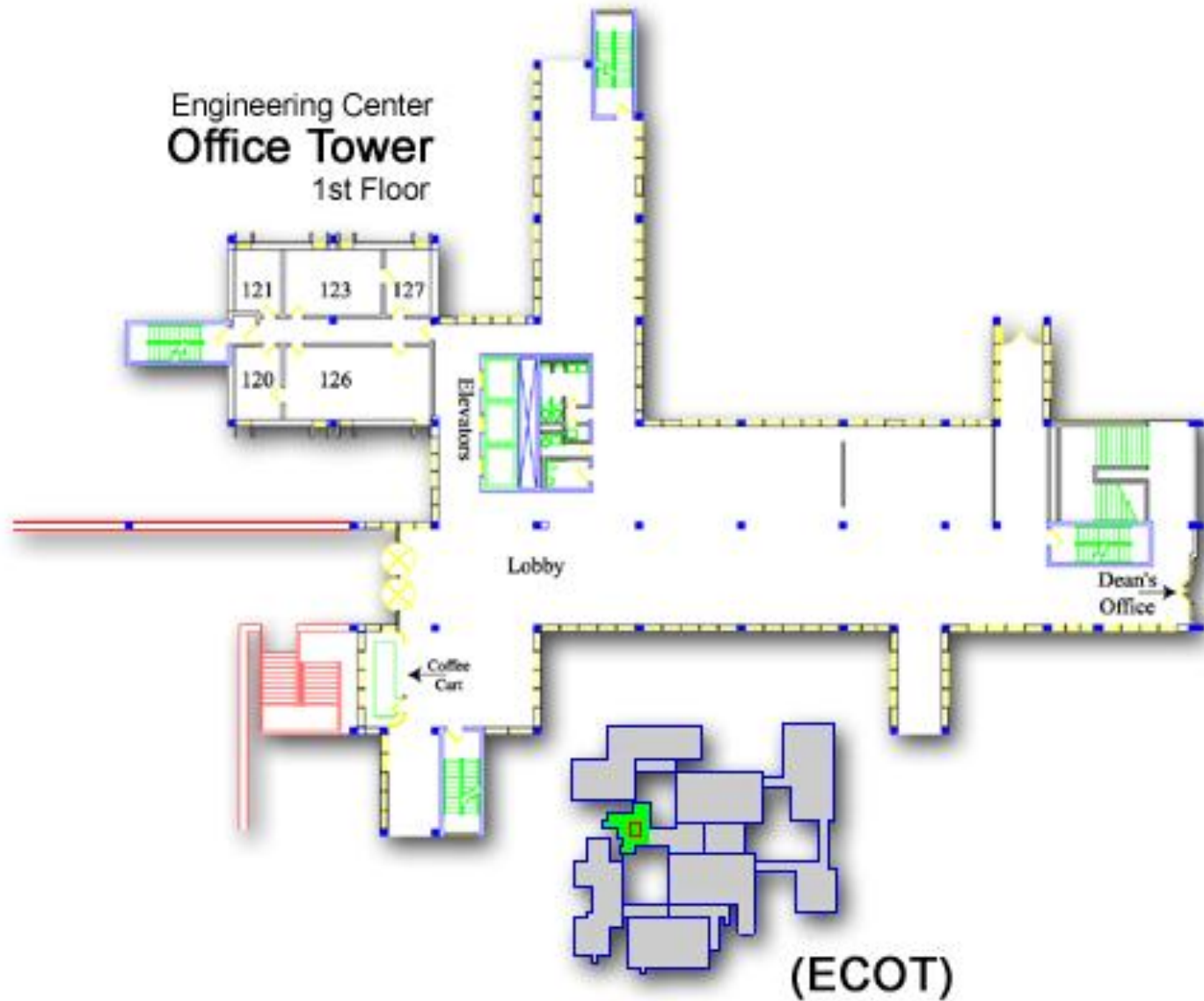

Engineering Center
Office Tower
2nd Floor

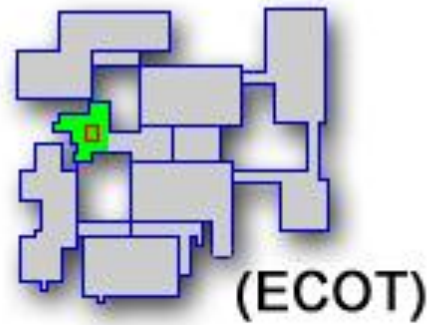
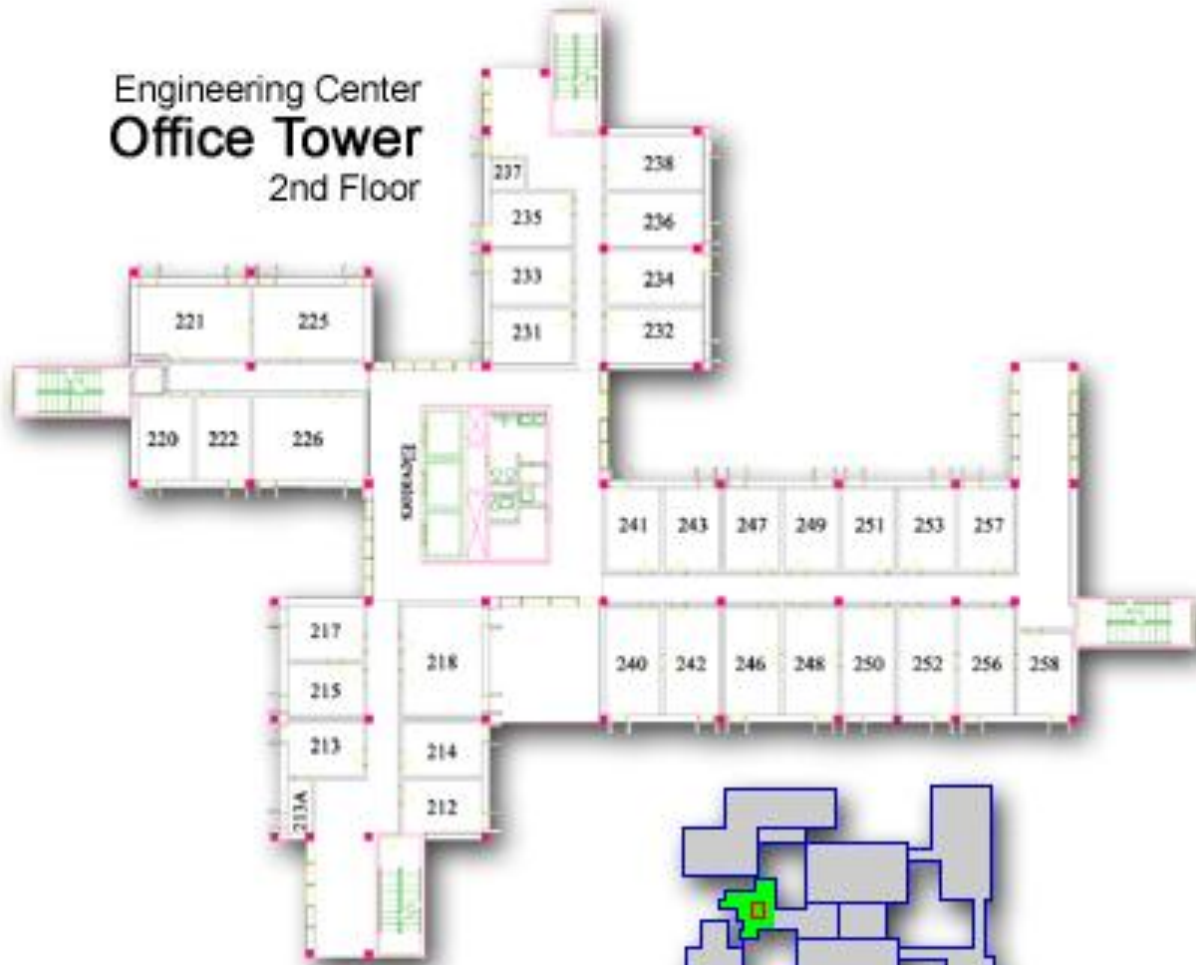

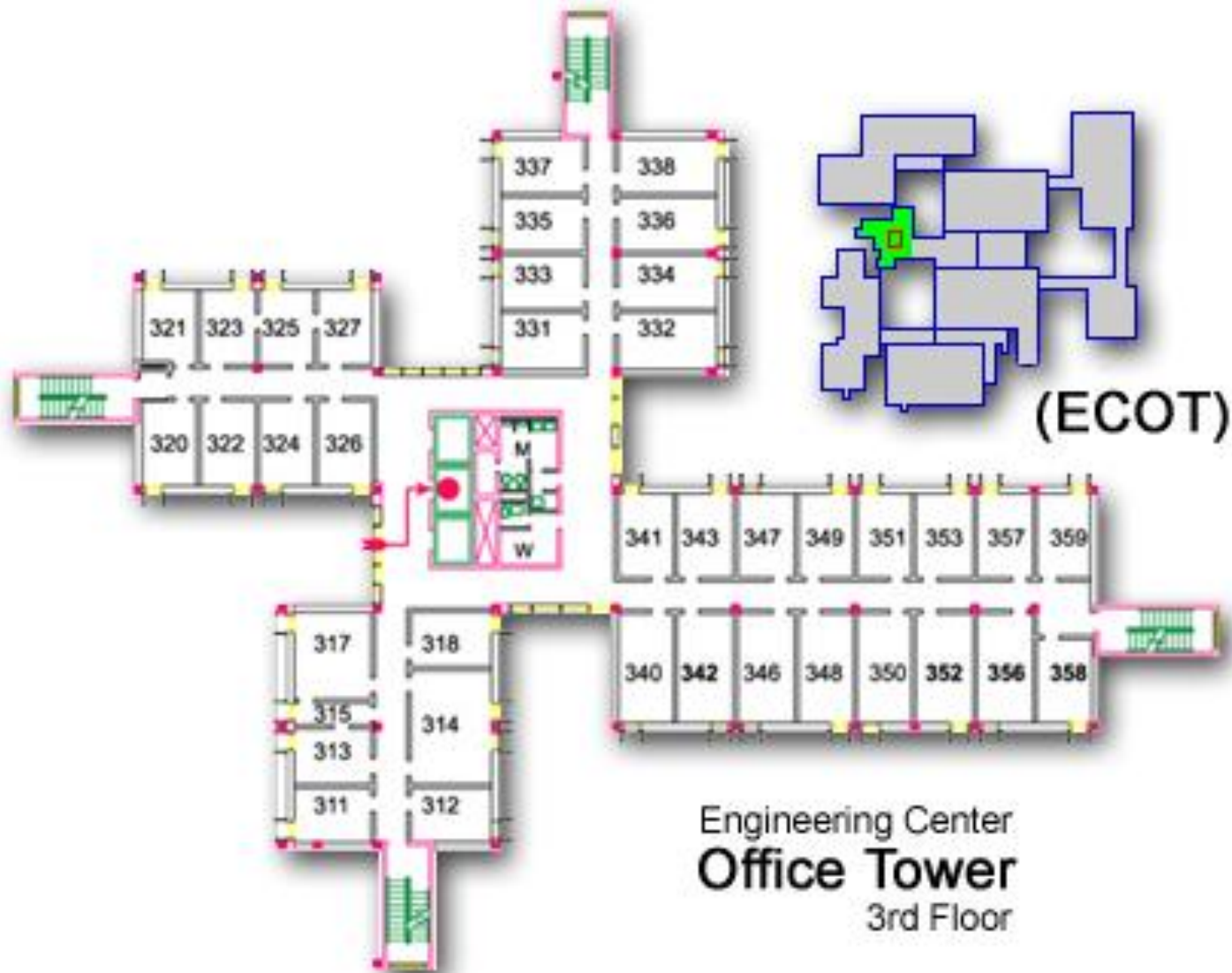

Engineering Center
Office Tower
4th Floor

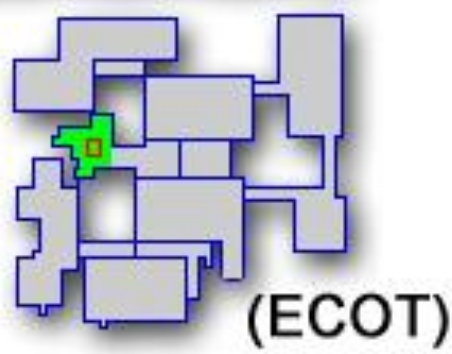

(ECOT)

Engineering Center
Office Tower
5th Floor

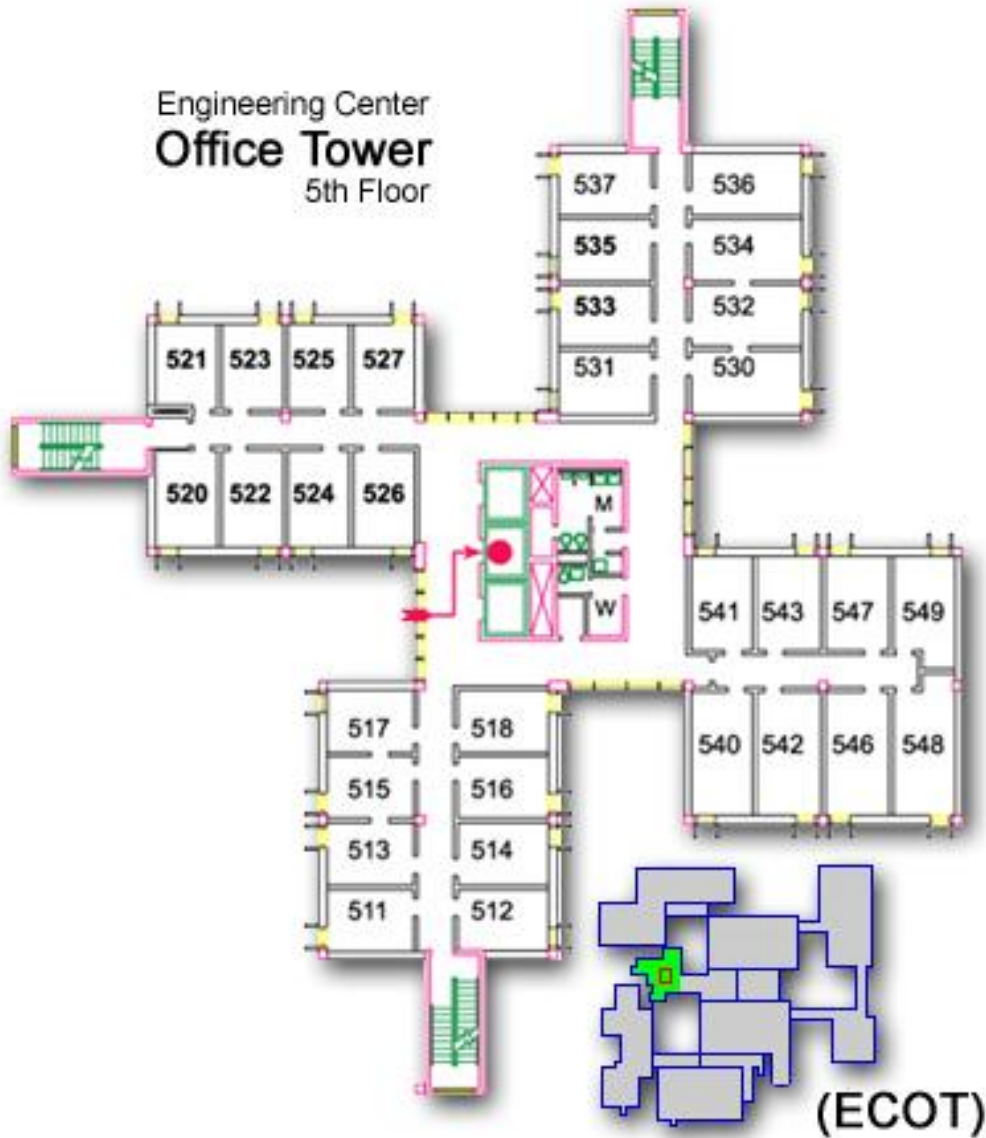

Engineering Center
Office Tower
6th Floor

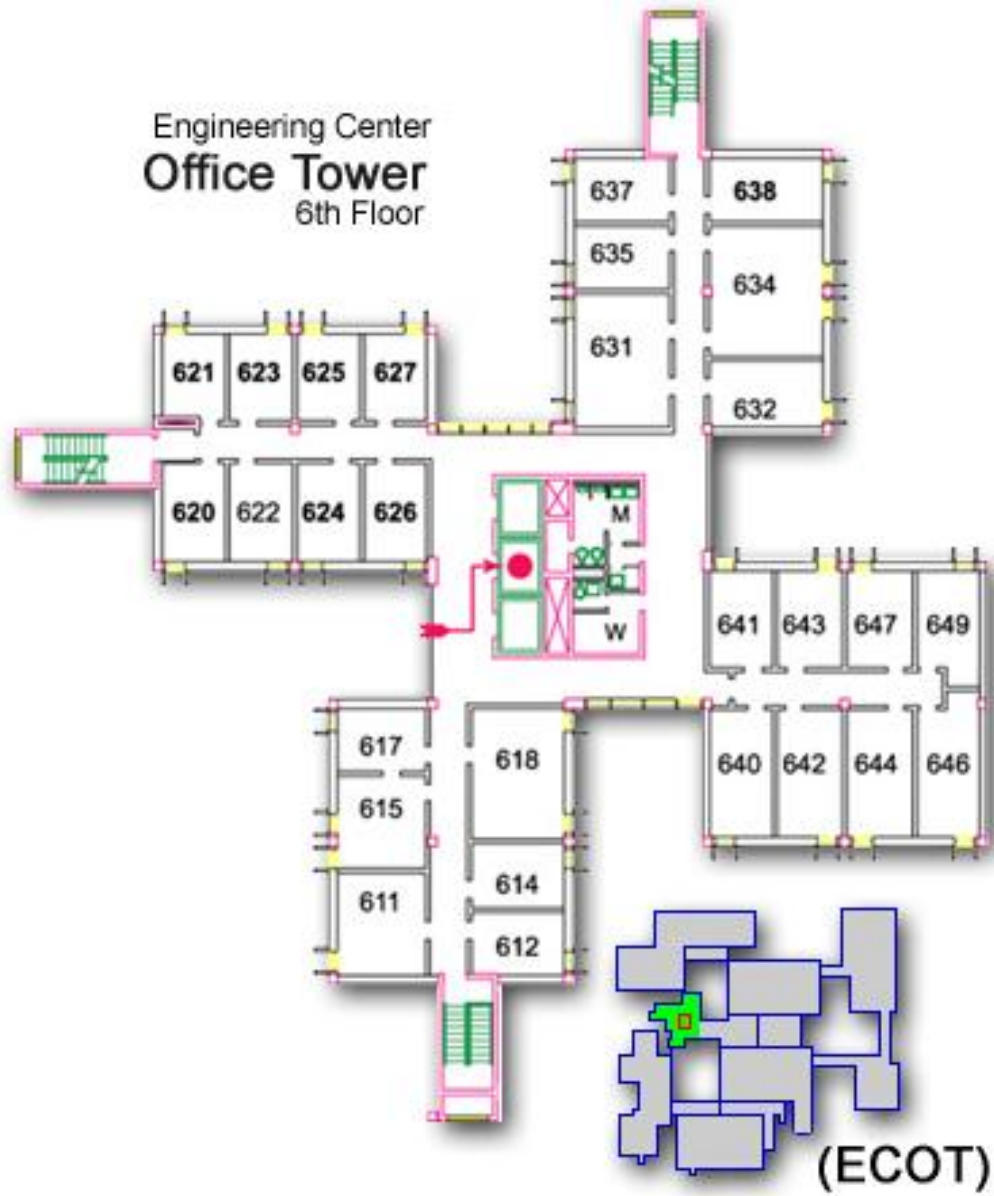

Engineering Center
Office Tower
7th Floor

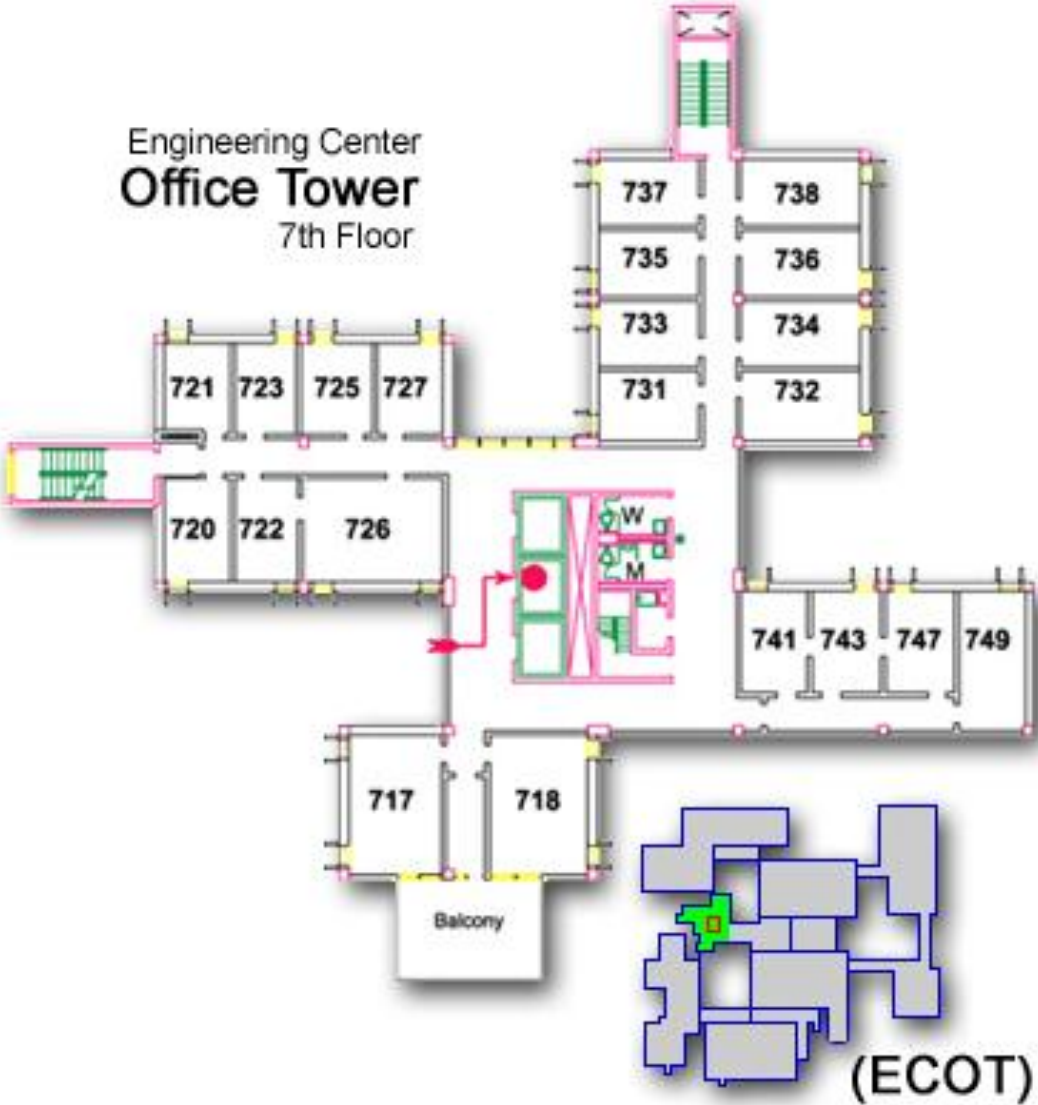

Engineering Center
Office Tower
8th Floor

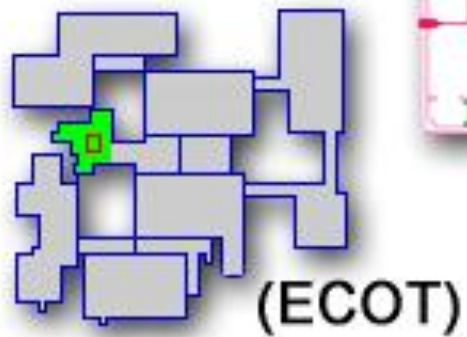

Computer Science Wing (ECCS)

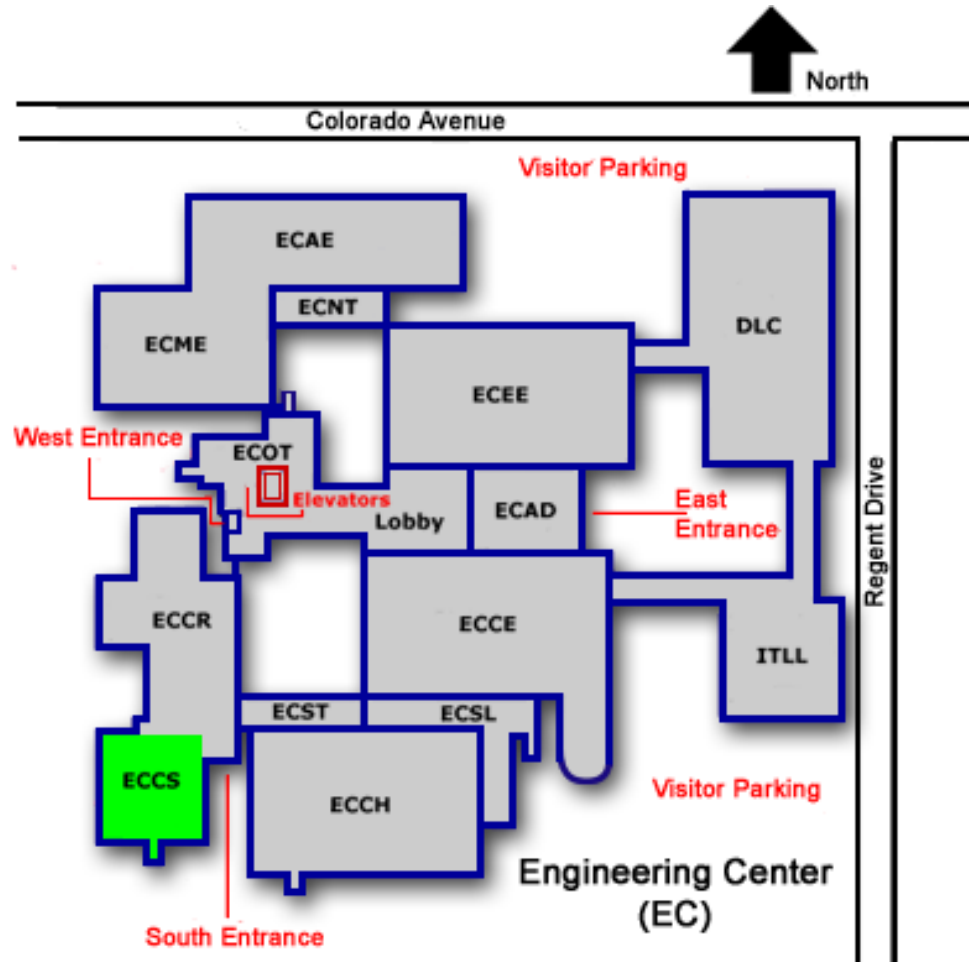

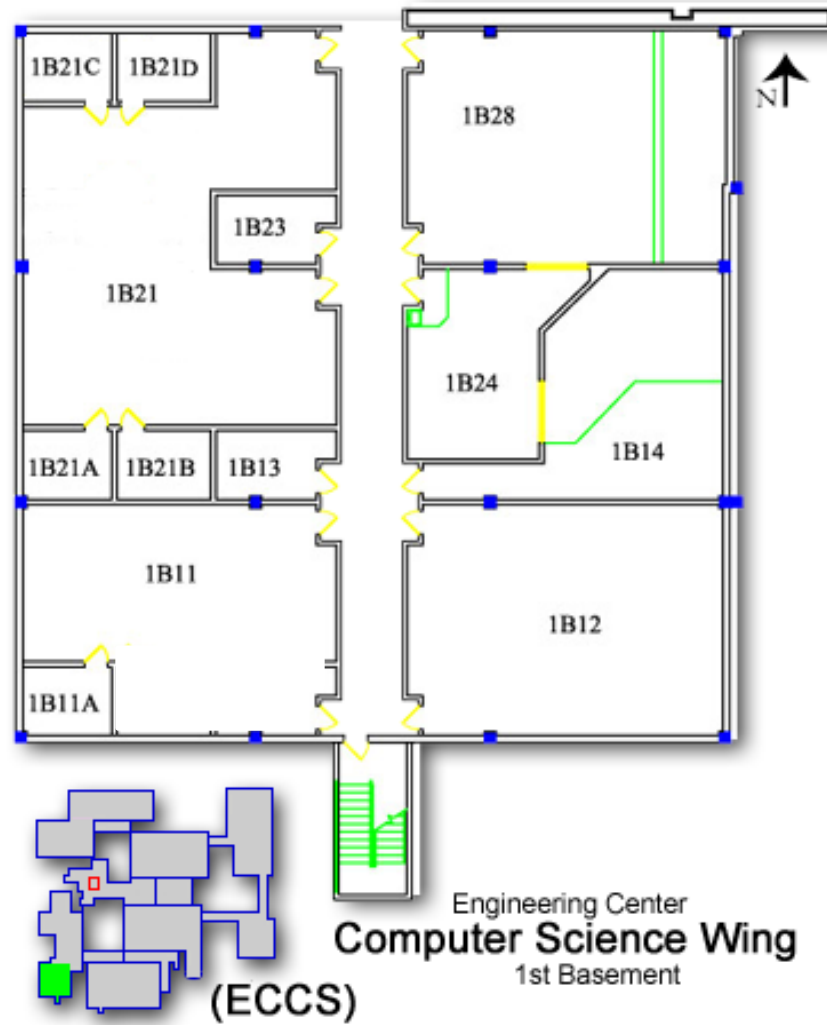

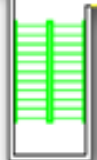
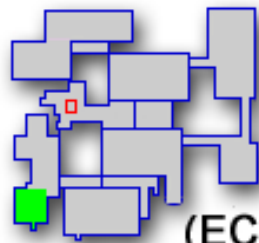
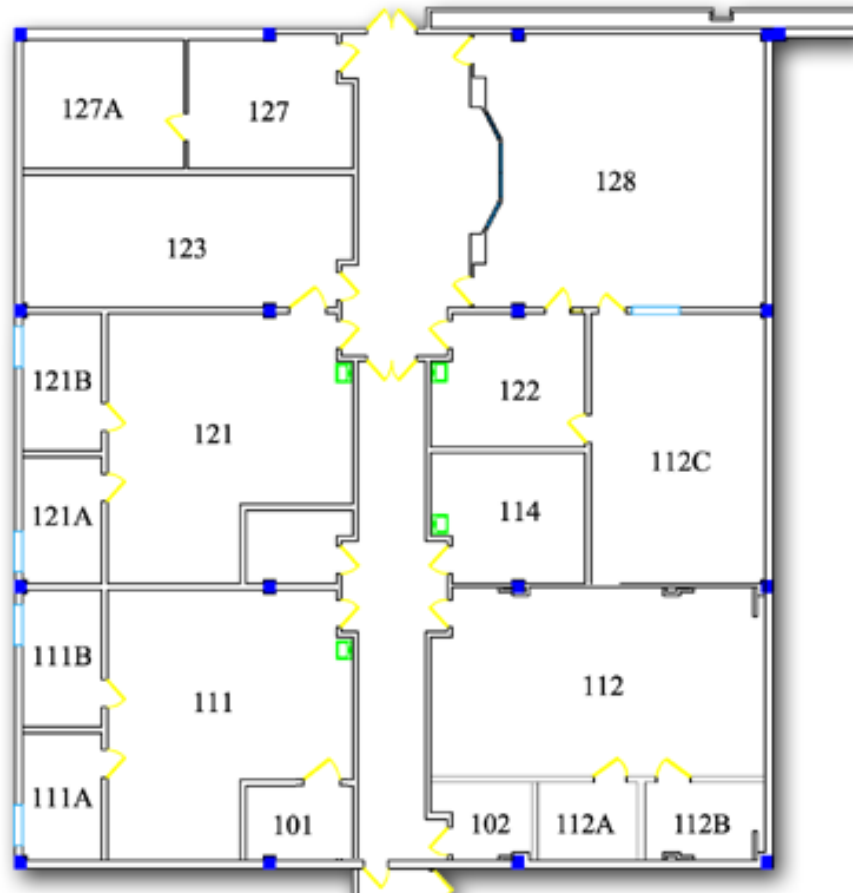

Engineering Center
Computer Science Wing
1st Floor

South Tower (ECST)

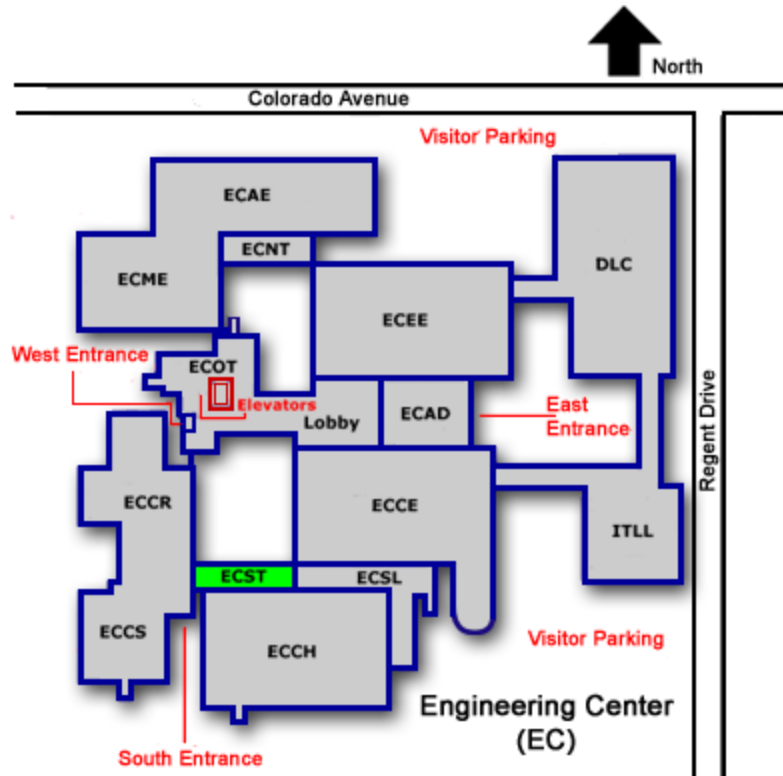

Engineering Center
South Tower
1st Basement

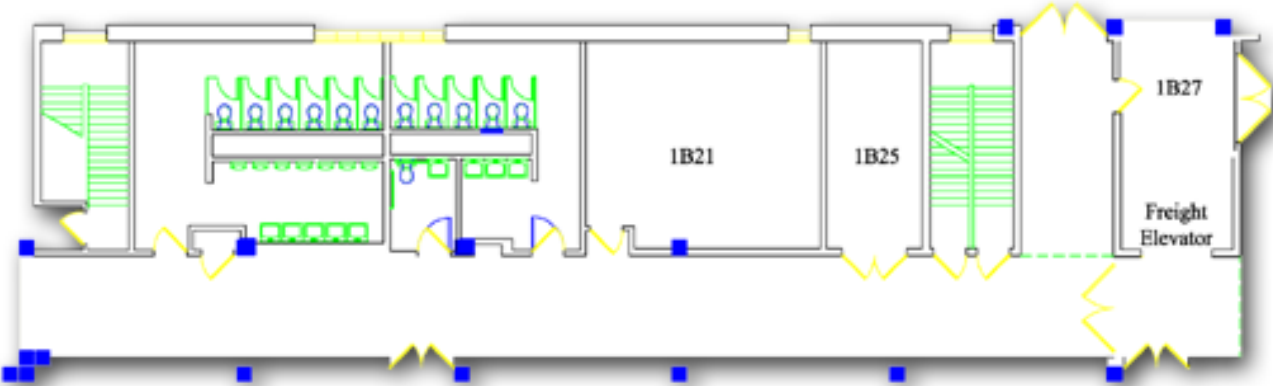

(ECST)

Engineering Center
South Tower
1st Floor

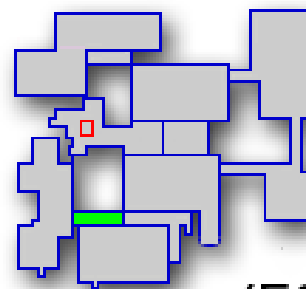
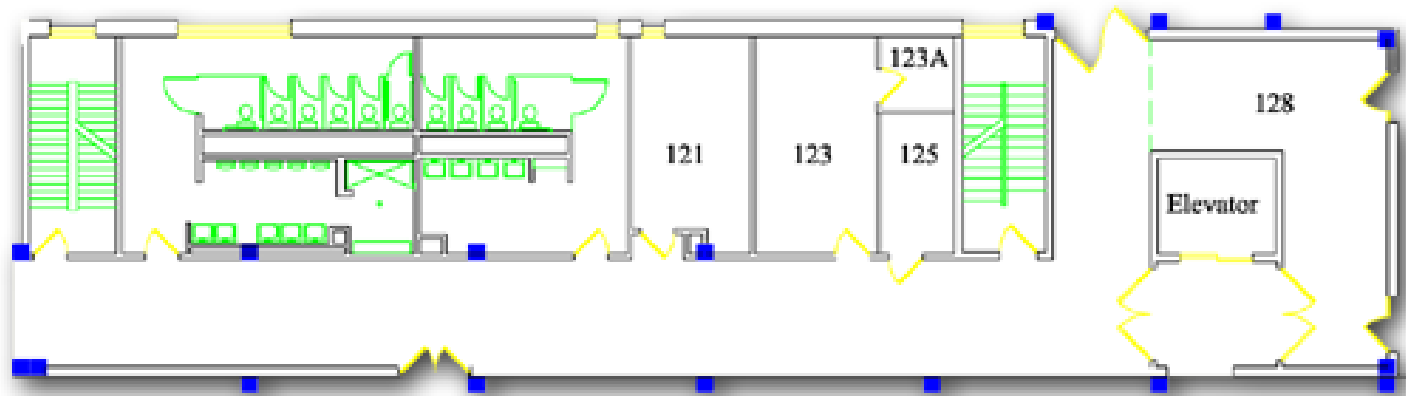

(ECST)

Engineering Center
South Tower
2nd Floor

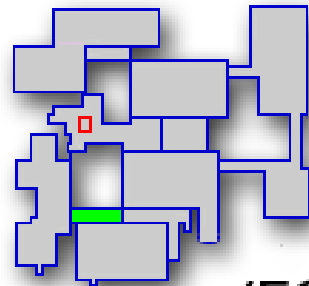
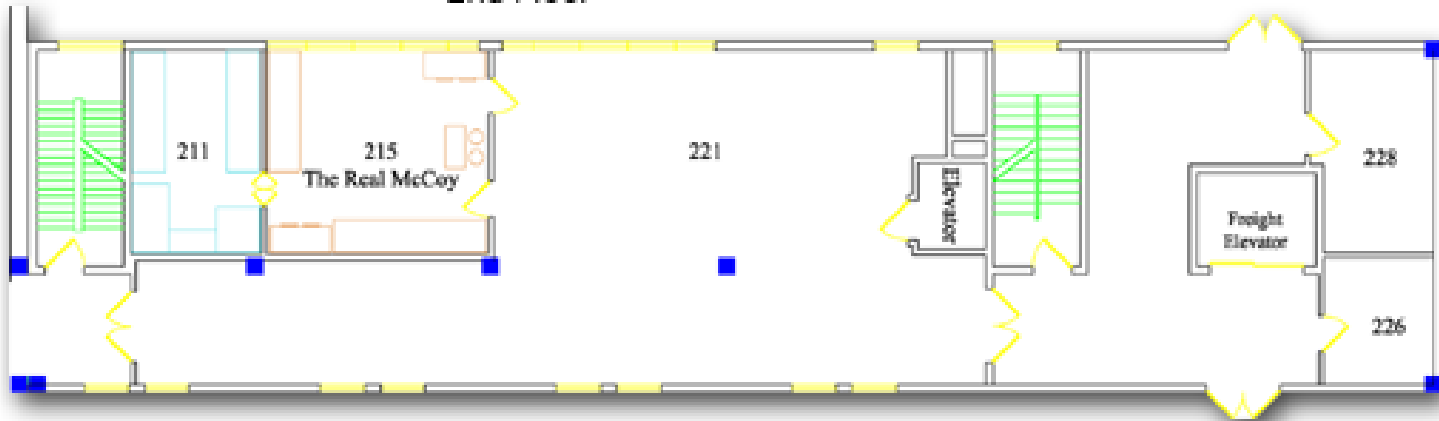

(ECST)

Engineering Center
South Tower
3rd Floor

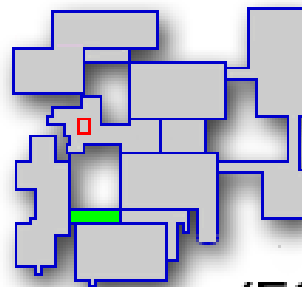
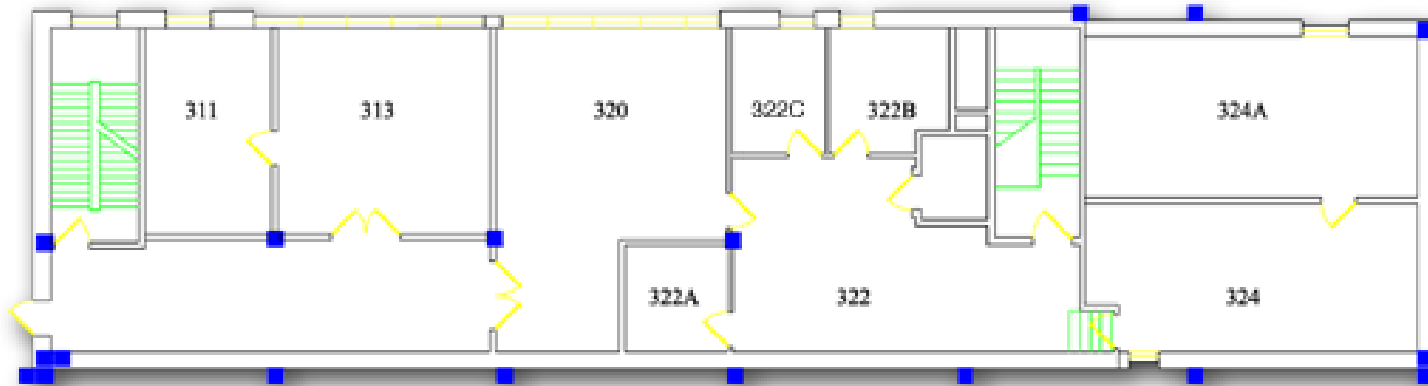

(ECST)

Classroom Wing (ECCR)

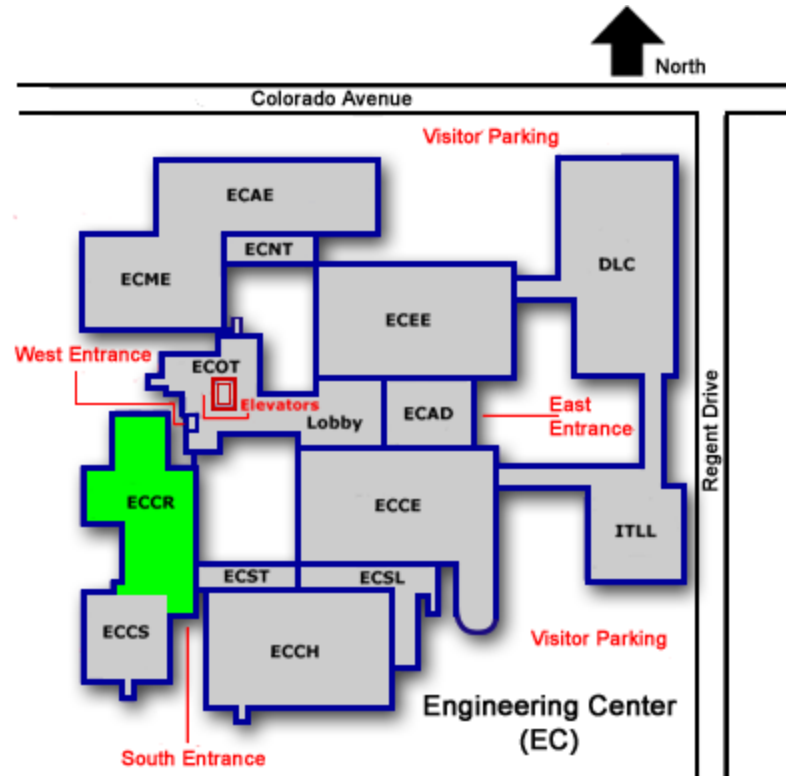

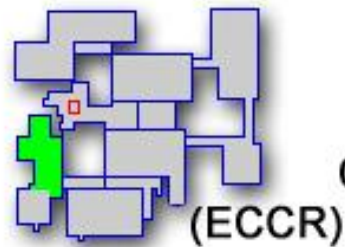
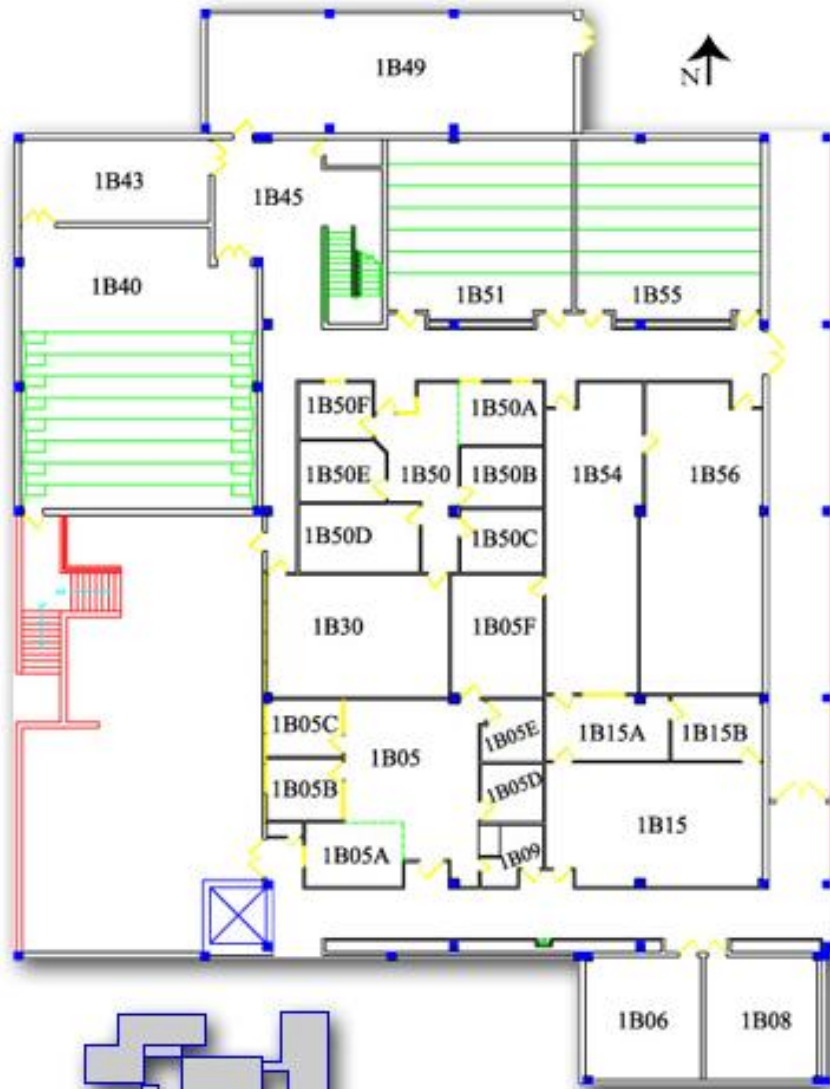

Engineering Center
Classroom Wing
 1st Basement

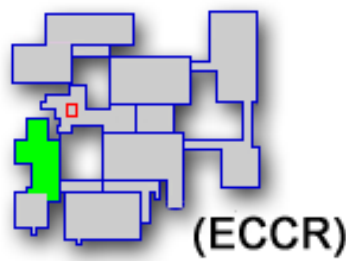
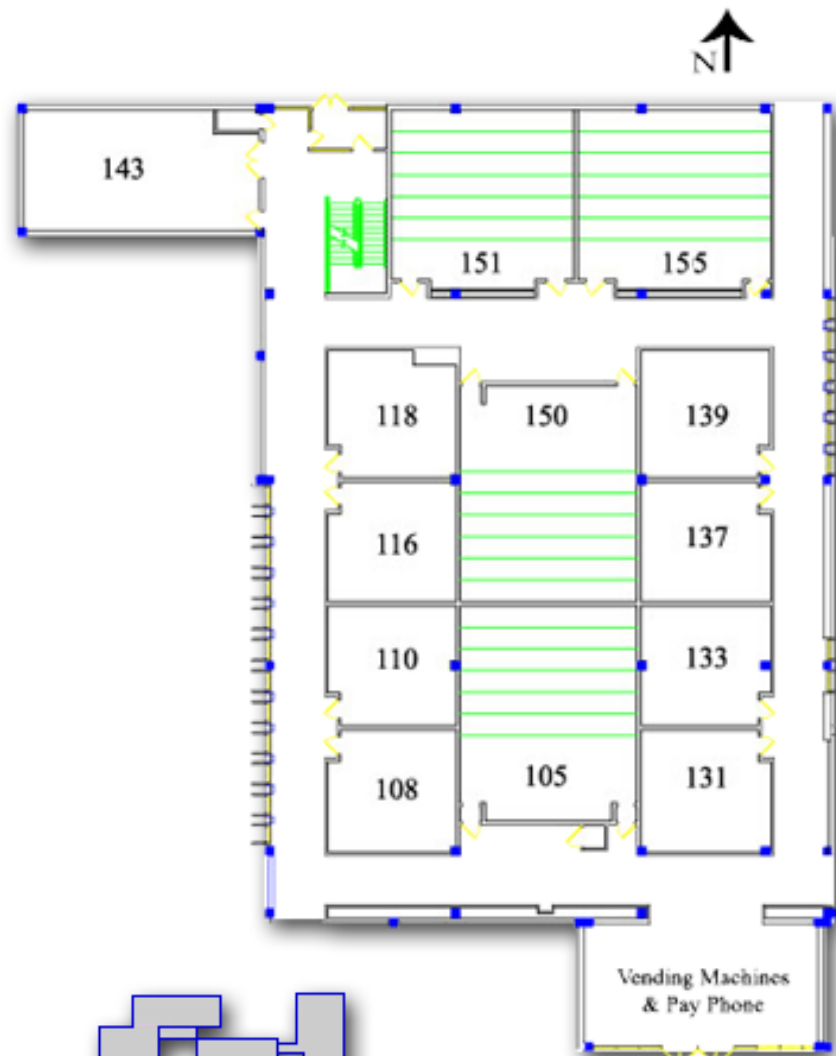

Engineering Center
Classroom Wing
1st Floor



Chemical Engineering Wing (ECCH)

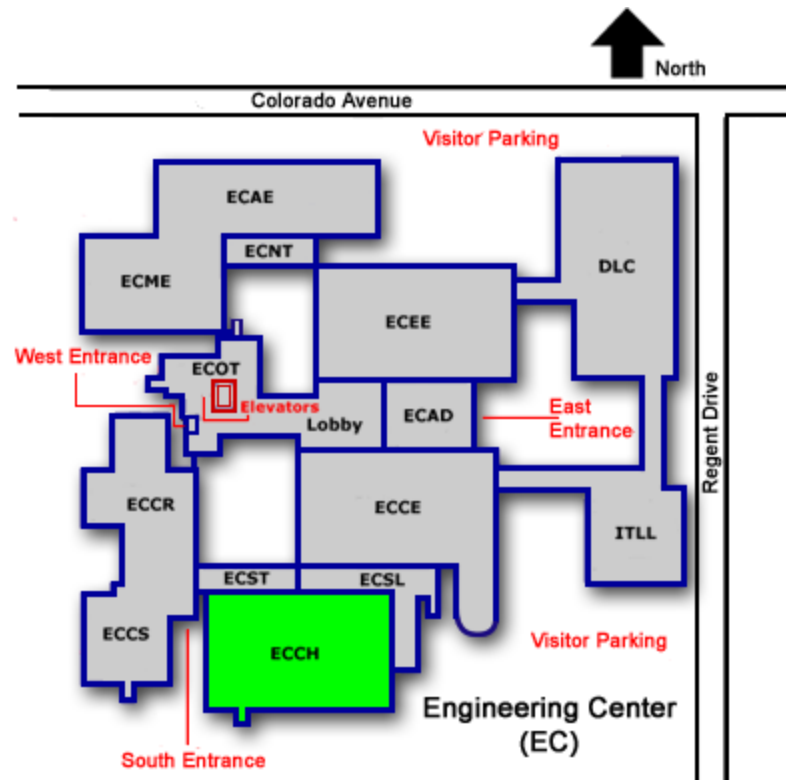

Engineering Center
Chemical Engineering Wing
1st Basement

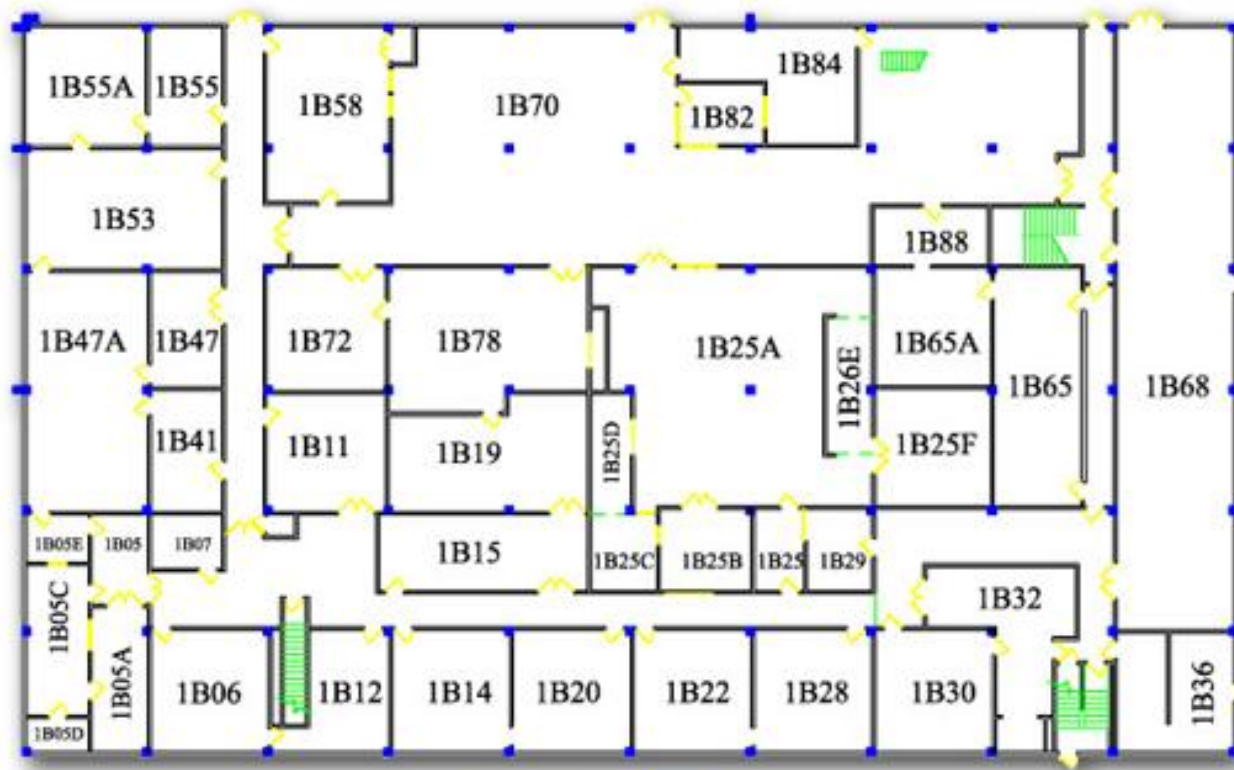

(ECCH)

Engineering Center
Chemical Engineering Wing
1st Floor

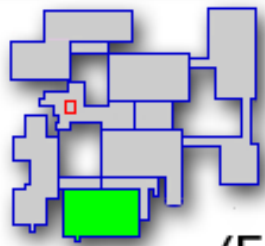

(ECCH)

Aerospace Engineering Wing (ECAE)

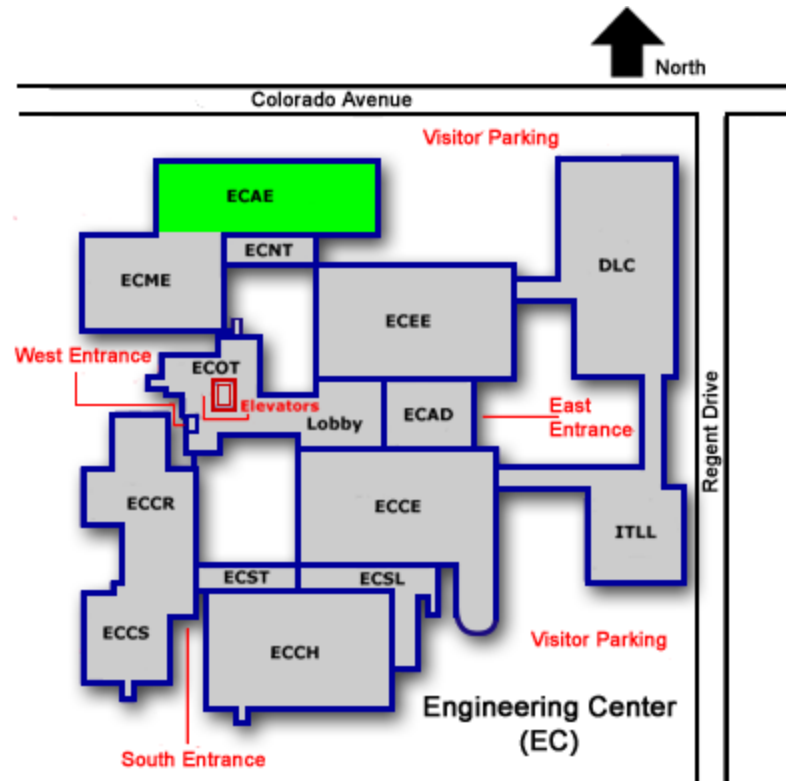

Engineering Center
Aerospace Engineering Wing
1st Basement

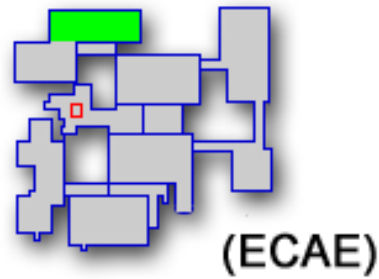
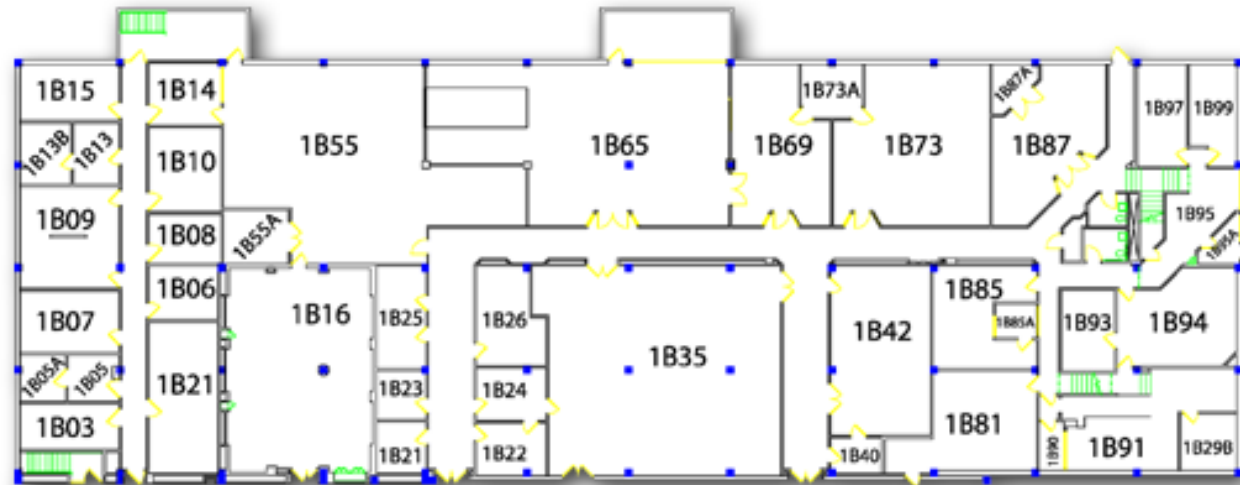

Engineering Center
Aerospace Engineering Wing
1st Floor

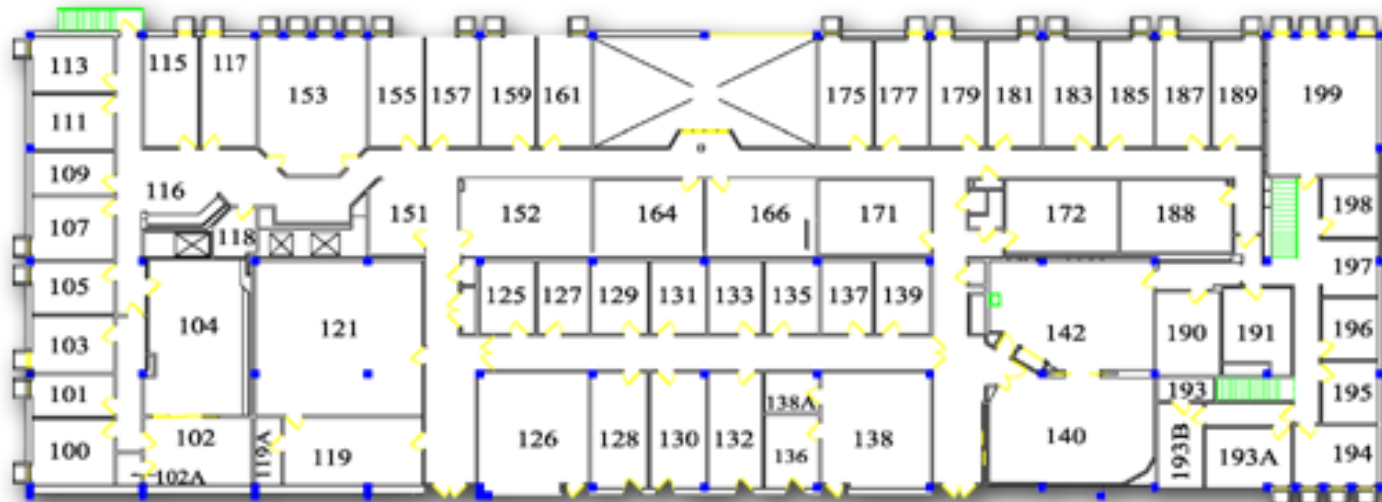

(ECAE)

Civil Engineering Wing (ECCE)

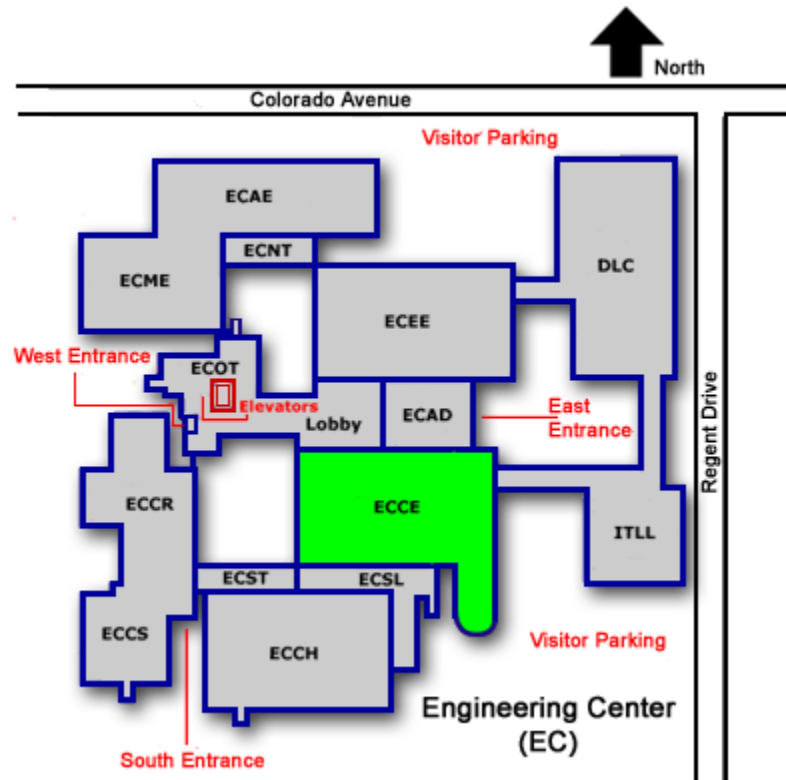

Engineering Center
Civil Engineering Wing
1st Basement

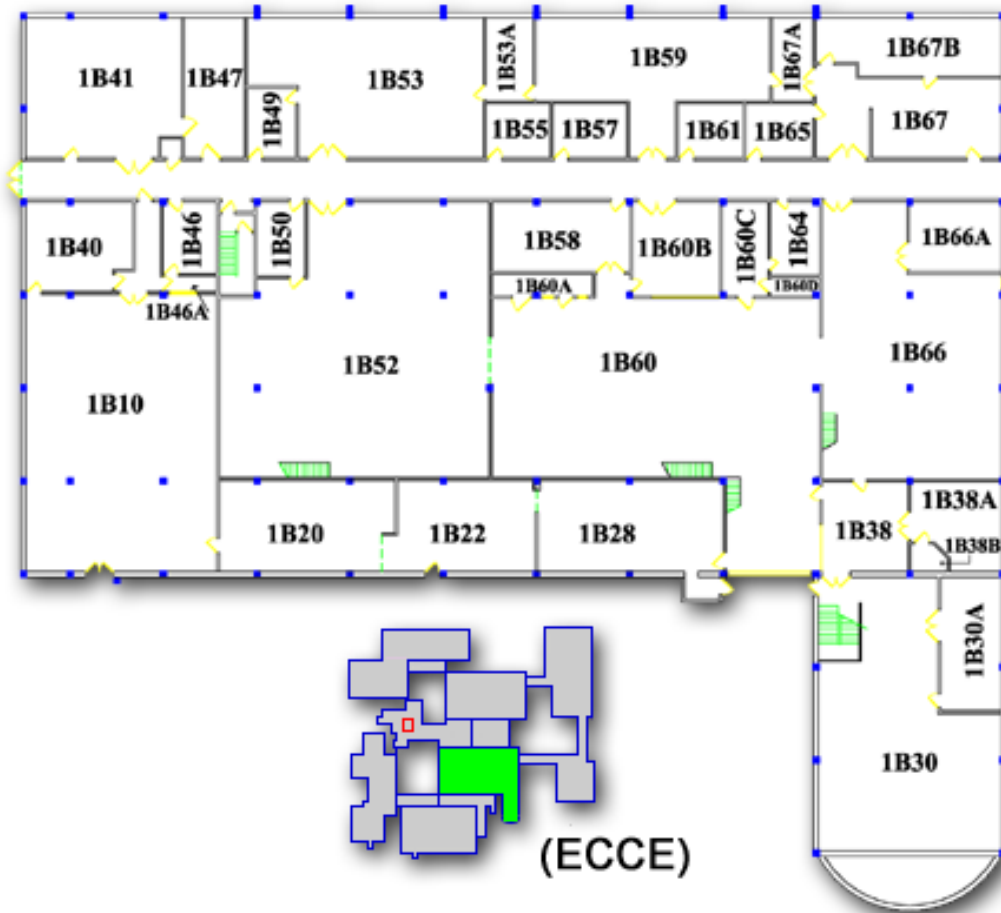

Engineering Center
Civil Engineering Wing
1st Floor

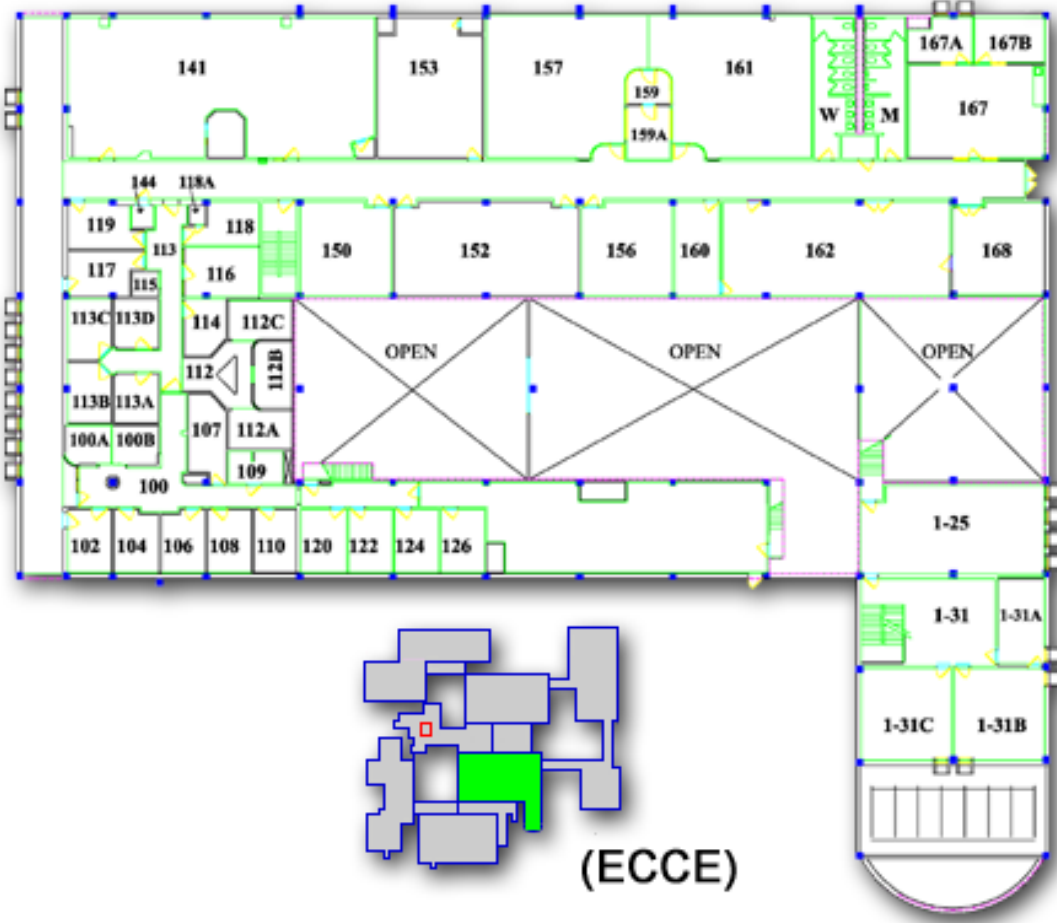

Engineering Center
Civil Engineering Wing
1st Floor

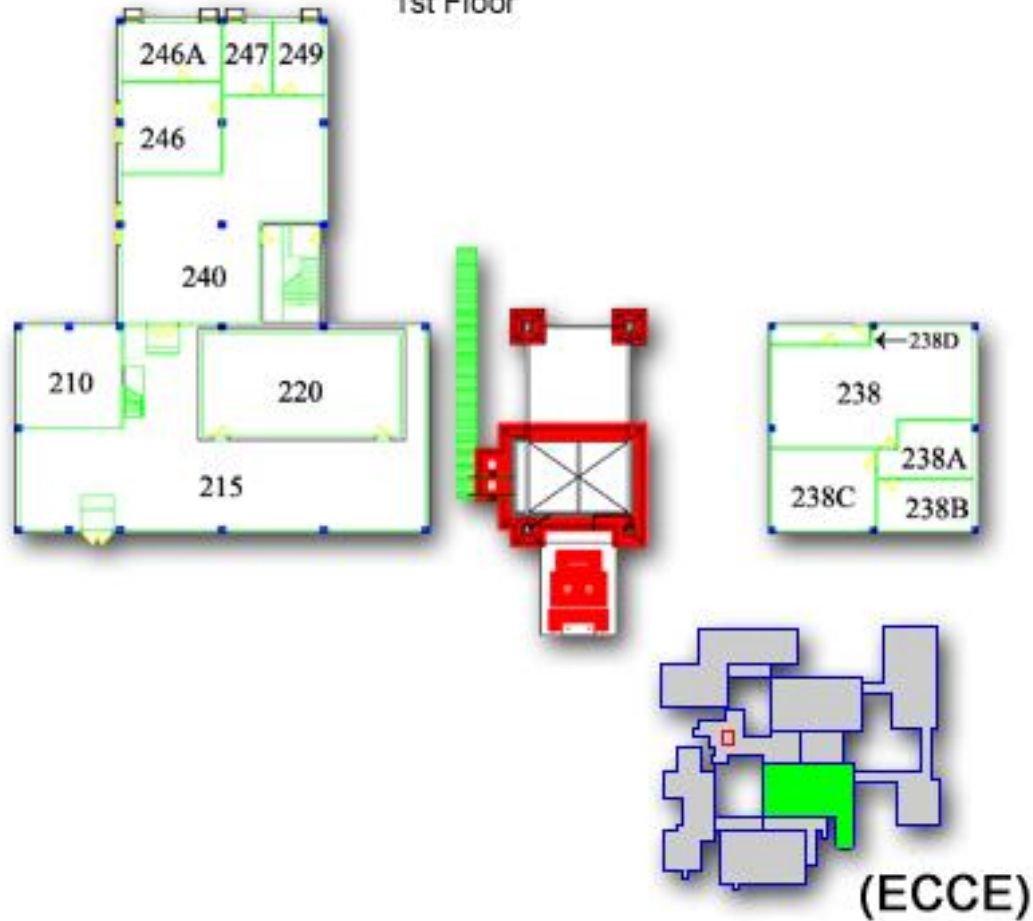

Electrical Engineering Wing (ECEE)

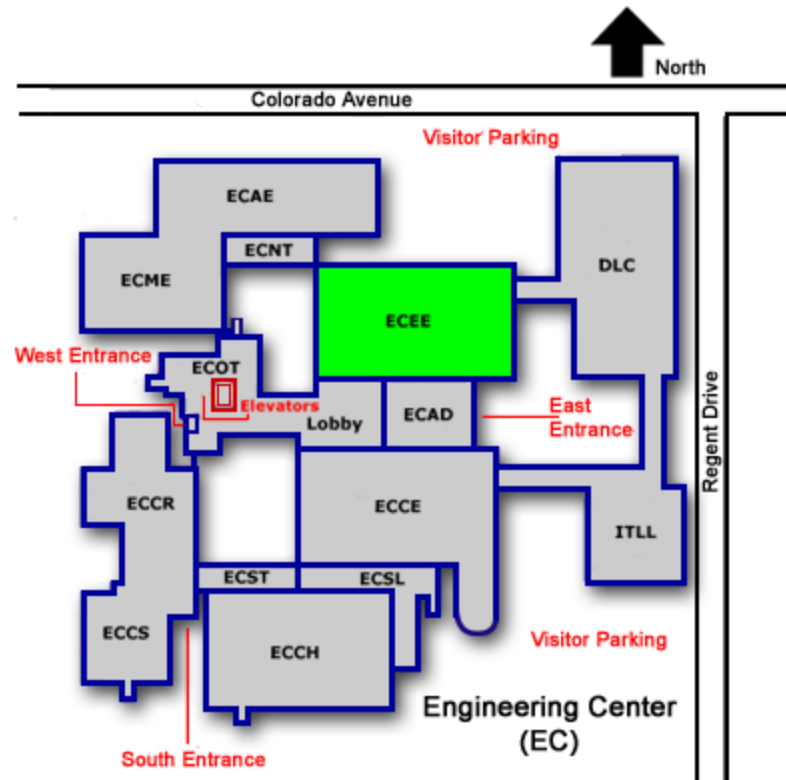

Engineering Center
Electrical Engineering Wing
2nd Basement

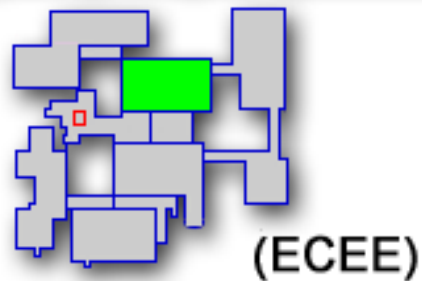
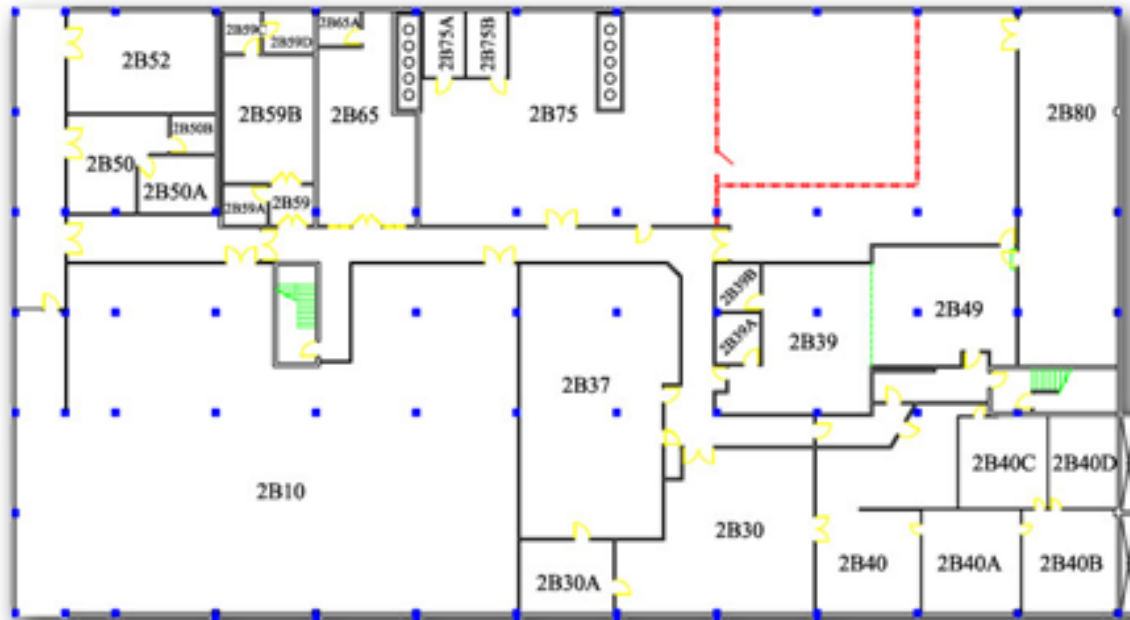

Engineering Center
Electrical Engineering Wing
1st Basement

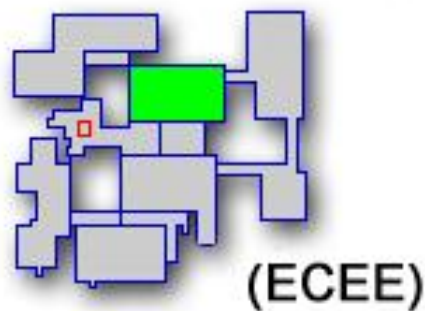
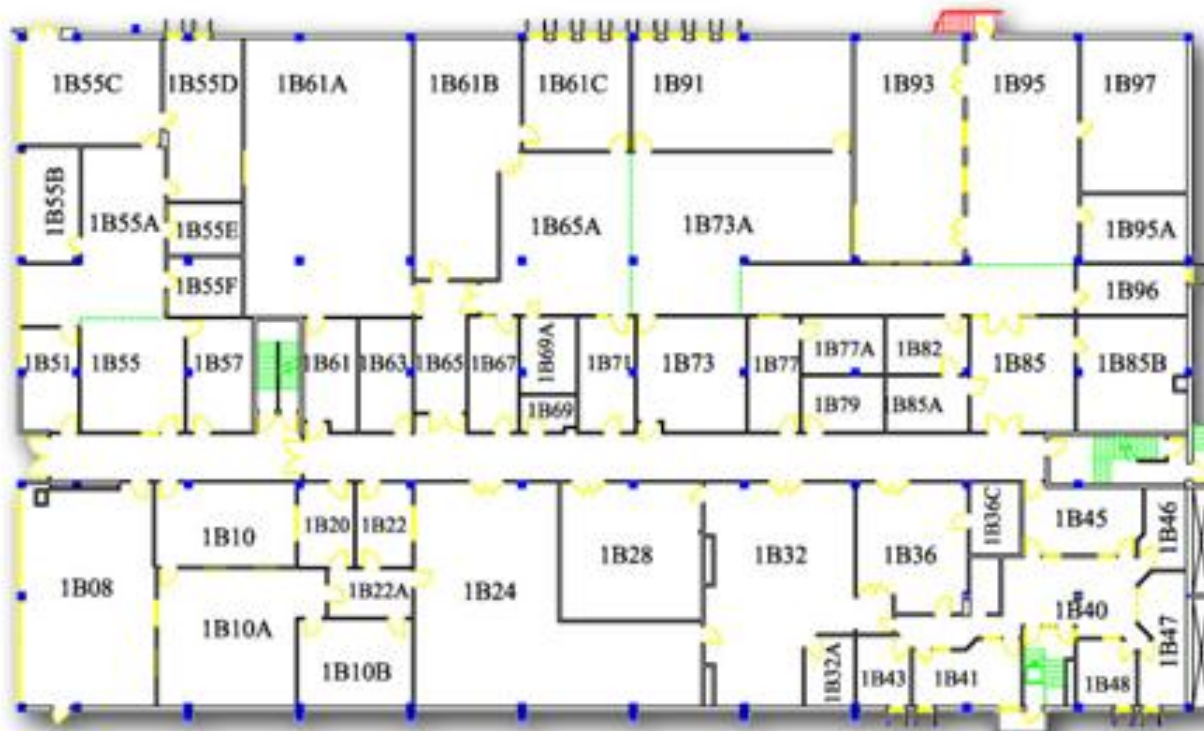

Engineering Center
Electrical Engineering Wing
1st Floor

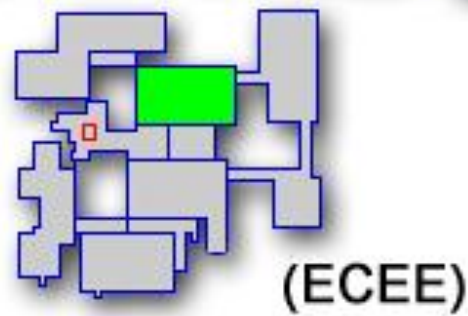
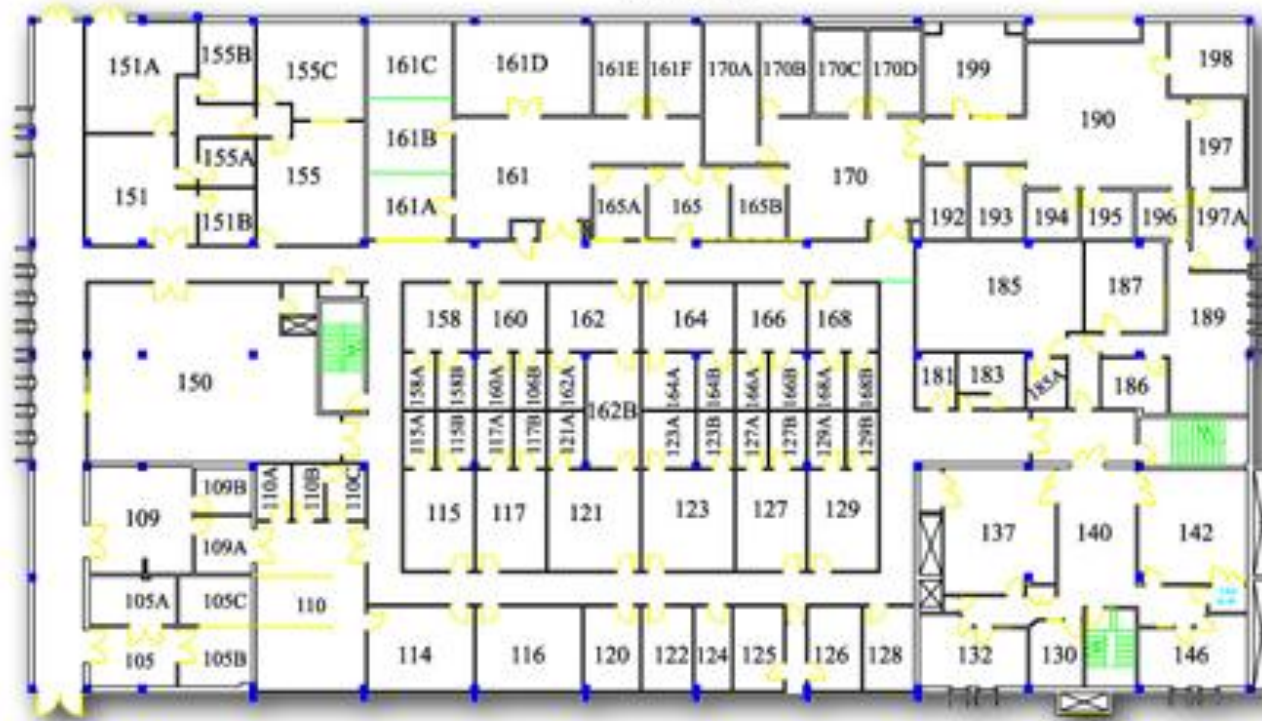

Engineering Center
Electrical Engineering Wing
2nd Floor

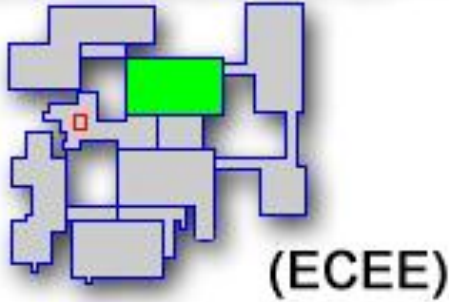

Mechanical Engineering Wing (ECME)

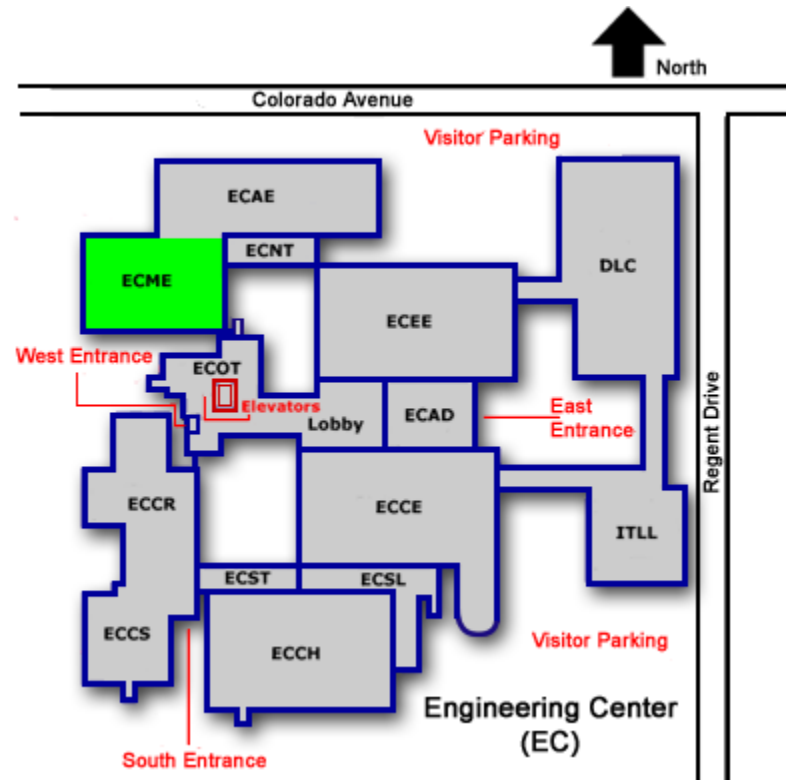

Engineering Center
Mechanical Engineering Wing
1st Basement

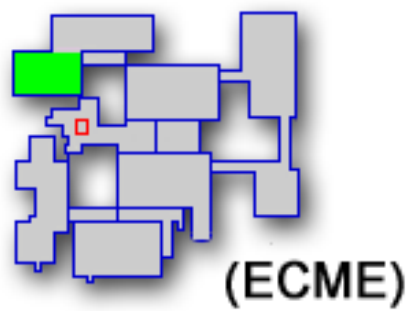
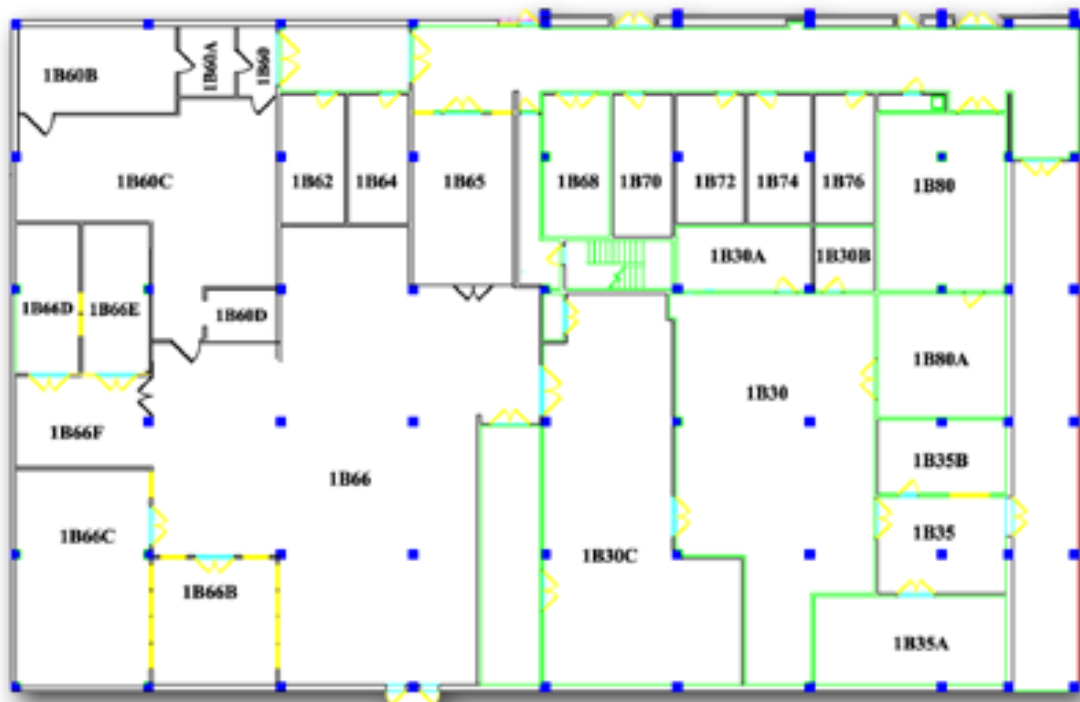

Engineering Center
Mechanical Engineering Wing
1st Floor

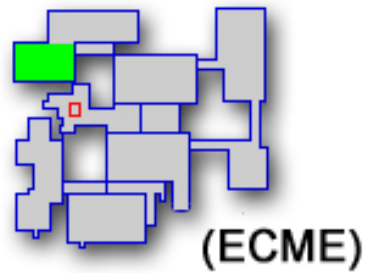
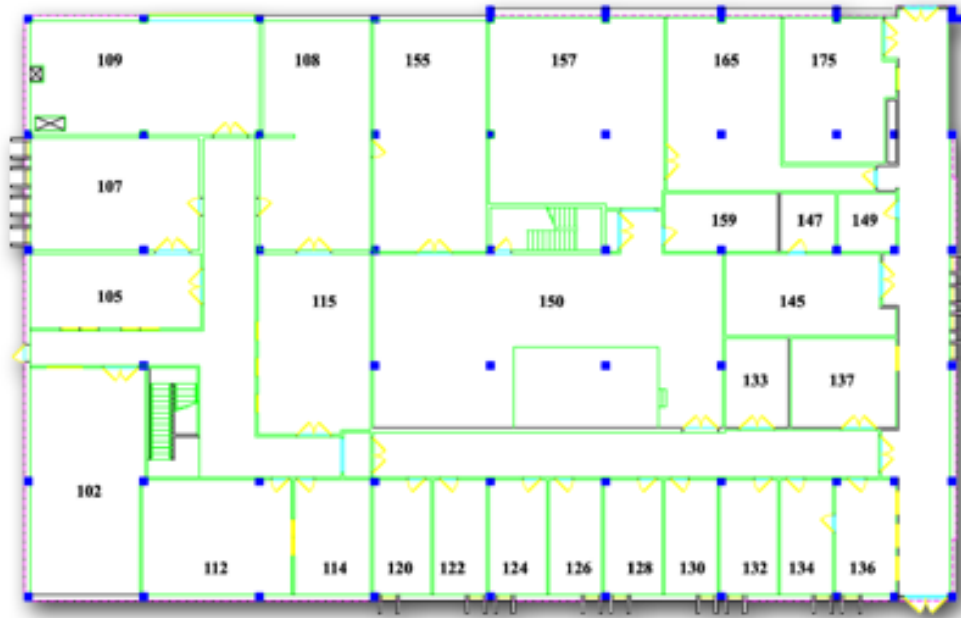

Engineering Center
Mechanical Engineering Wing
2nd Floor

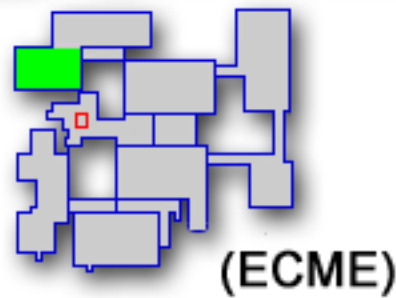
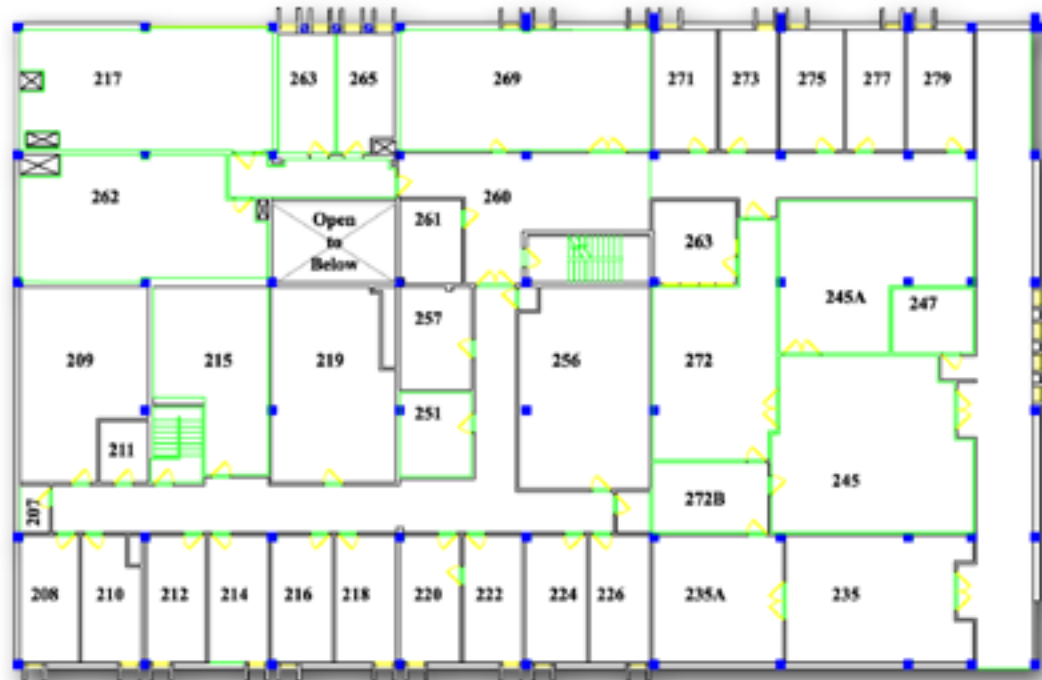

(ECME)

North Tower (ECNT)

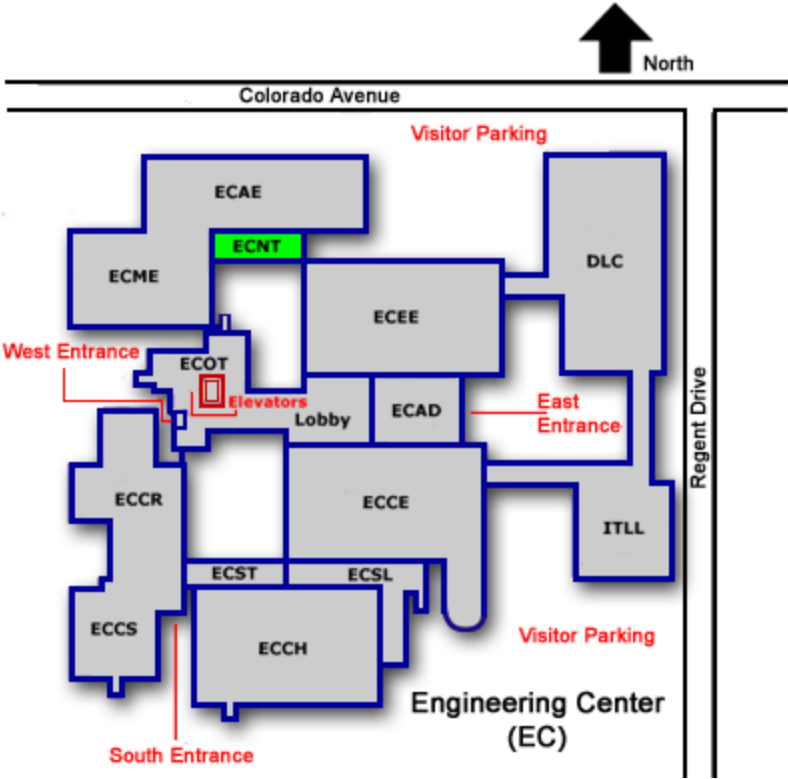

Engineering Center
North Tower
1st Basement

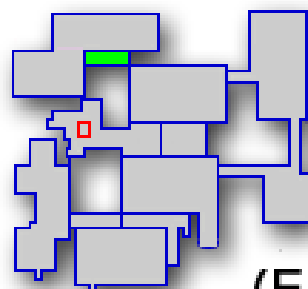
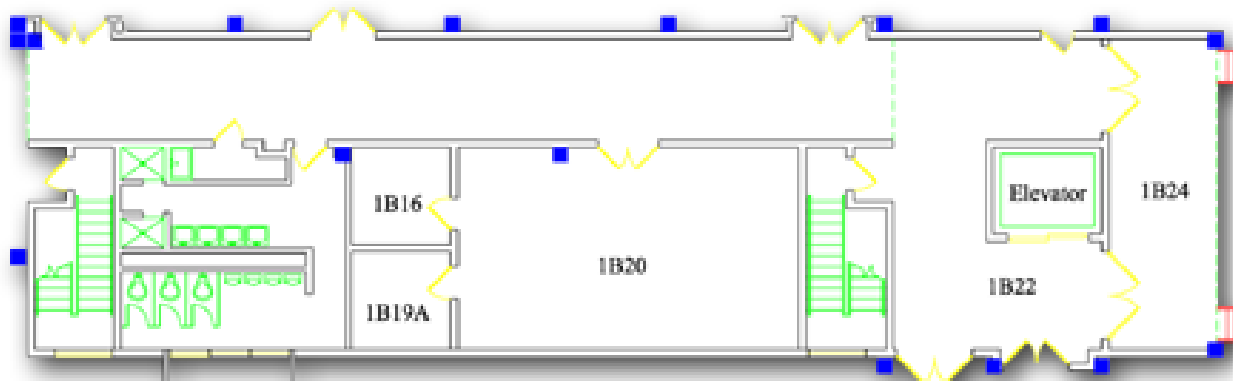

(ECNT)

Engineering Center
North Tower
1st Floor

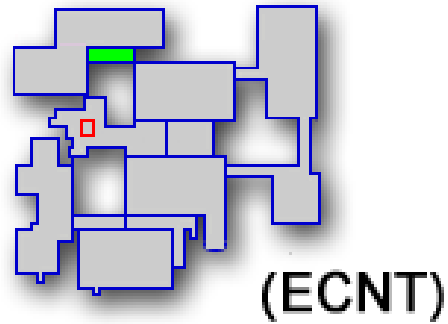
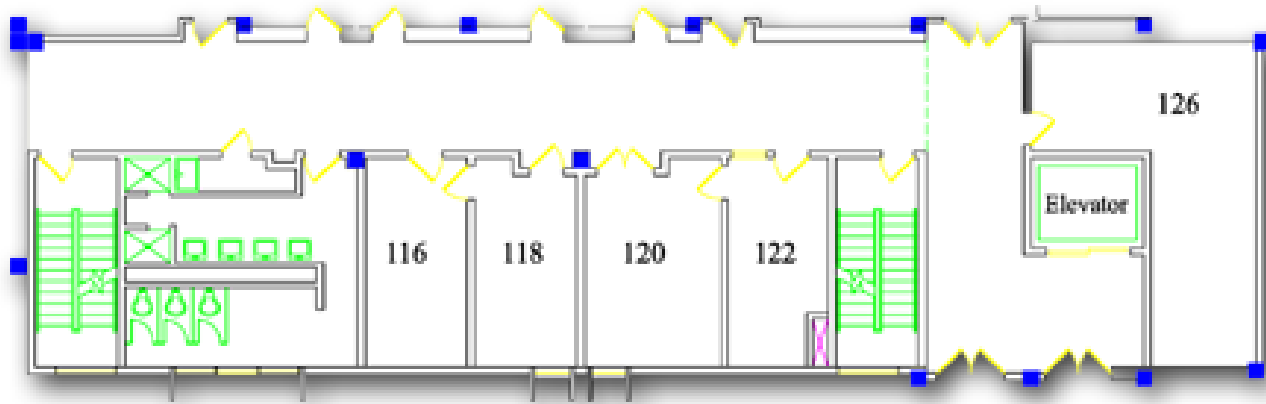

Engineering Center
North Tower
2nd Floor

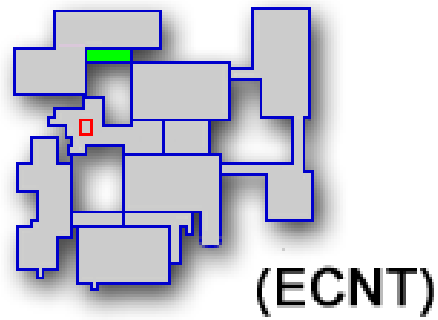
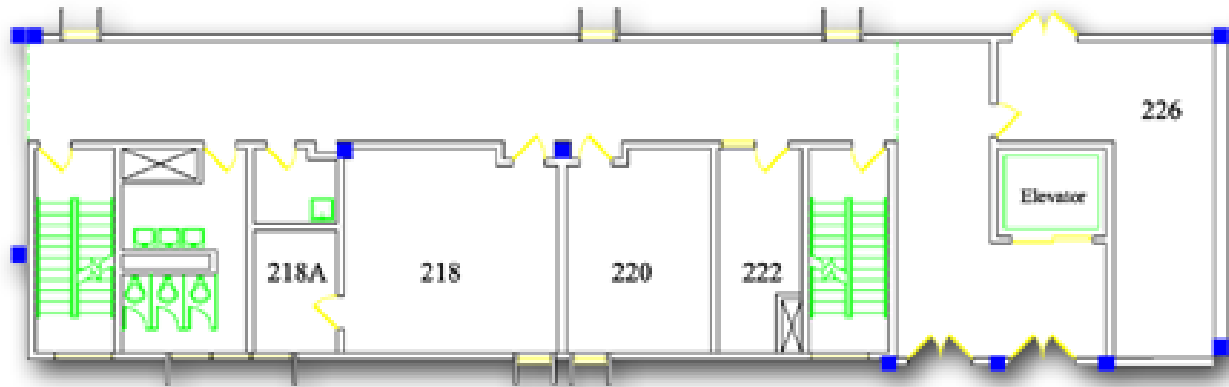

Engineering Center
North Tower
3rd Floor

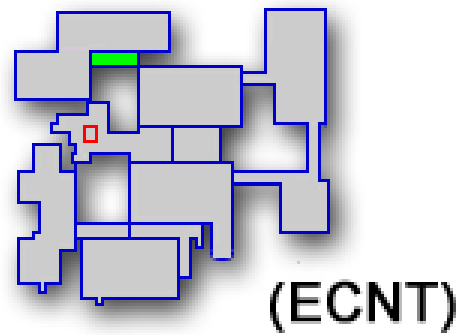

Engineering Center
North Tower
4th Floor

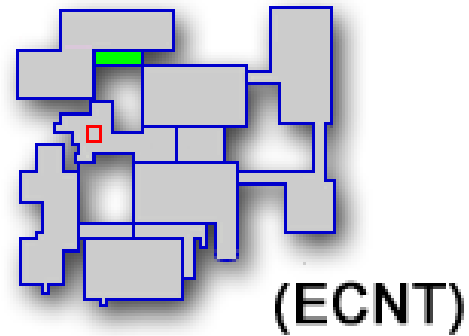
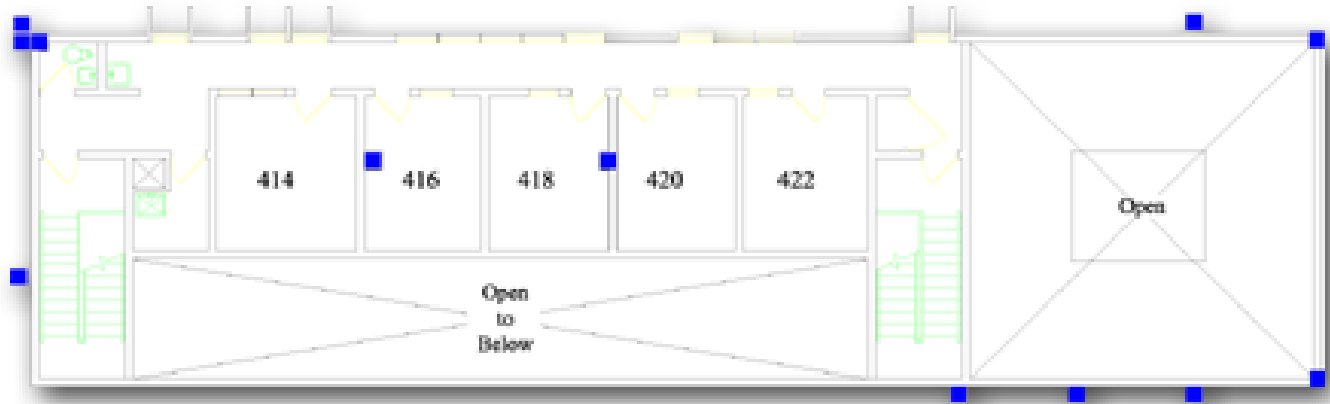

Stores and Labs (ECSL)

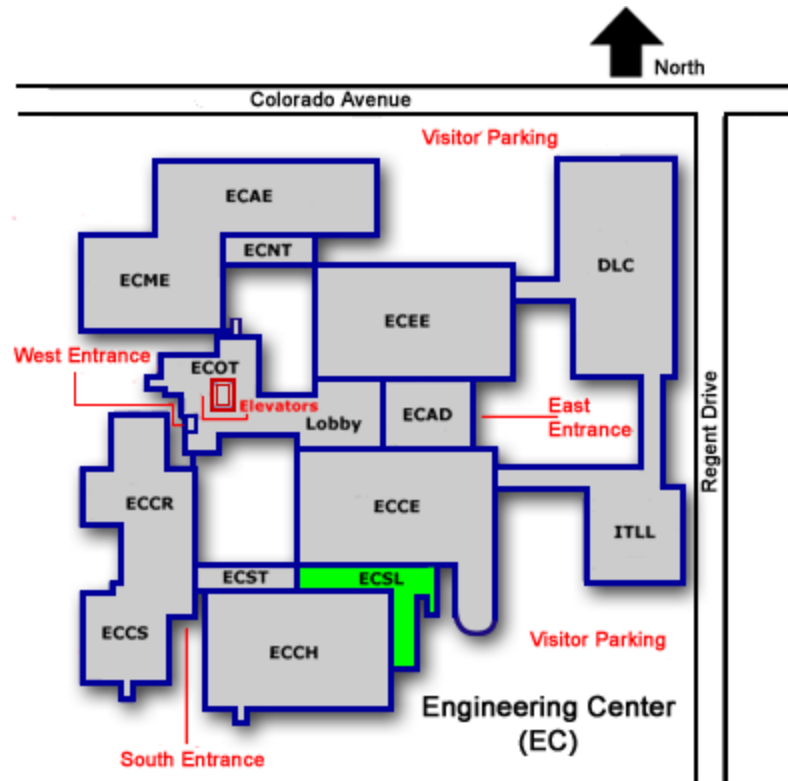

Engineering Center
Stores and Labs
1st Basement

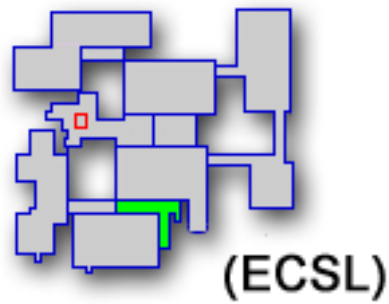
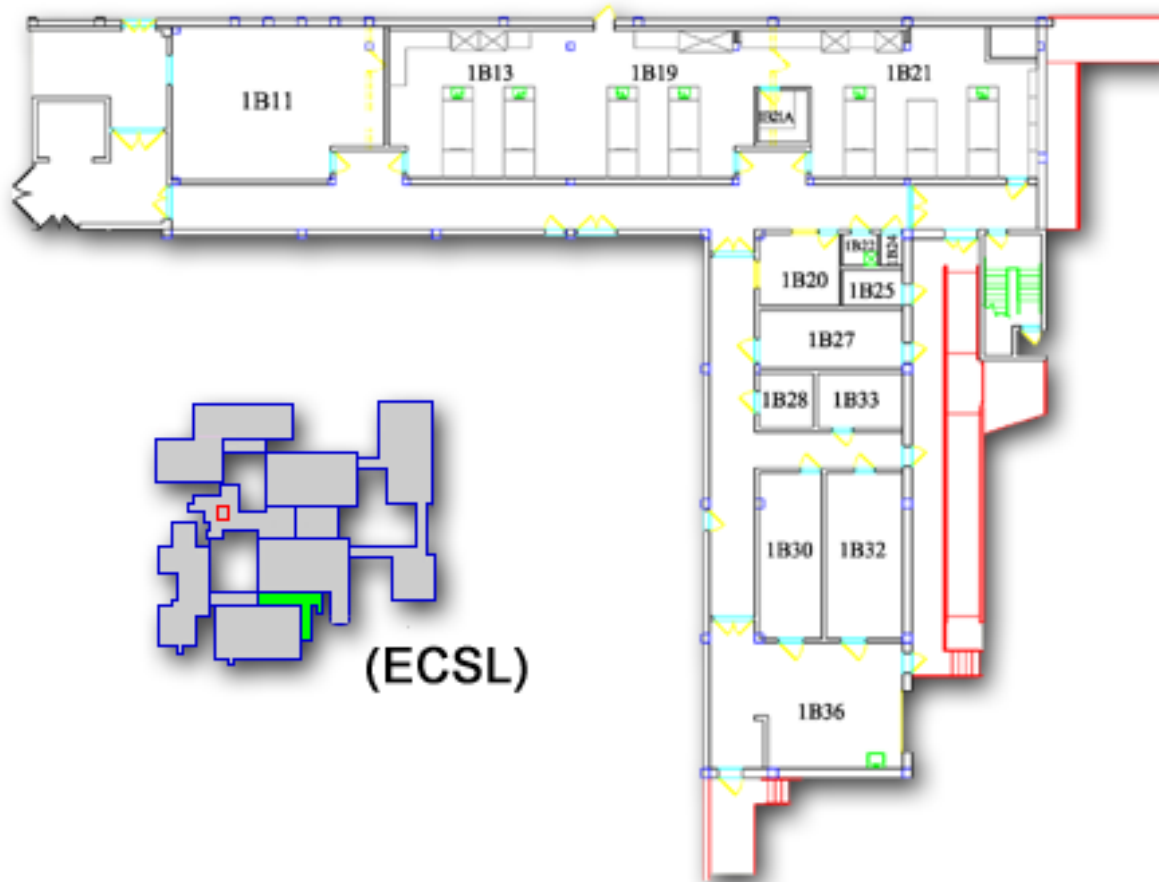

Engineering Center
Stores and Labs
1st Floor

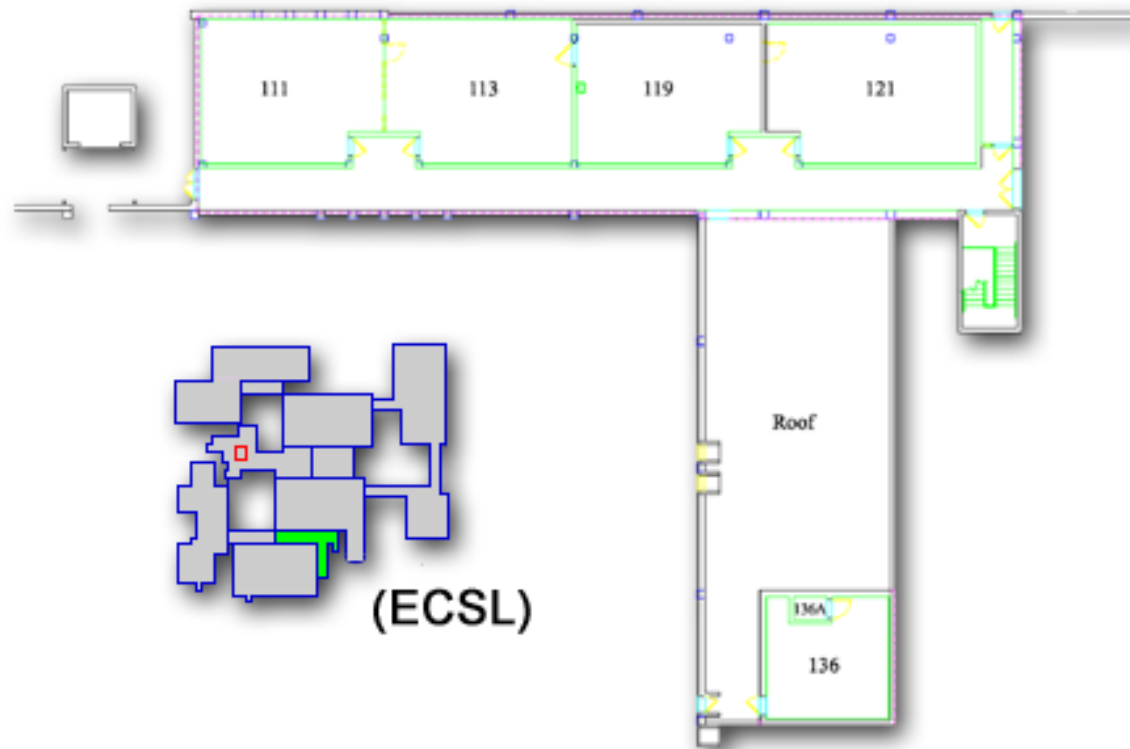

Engineering Center
Stores and Labs
2nd Floor

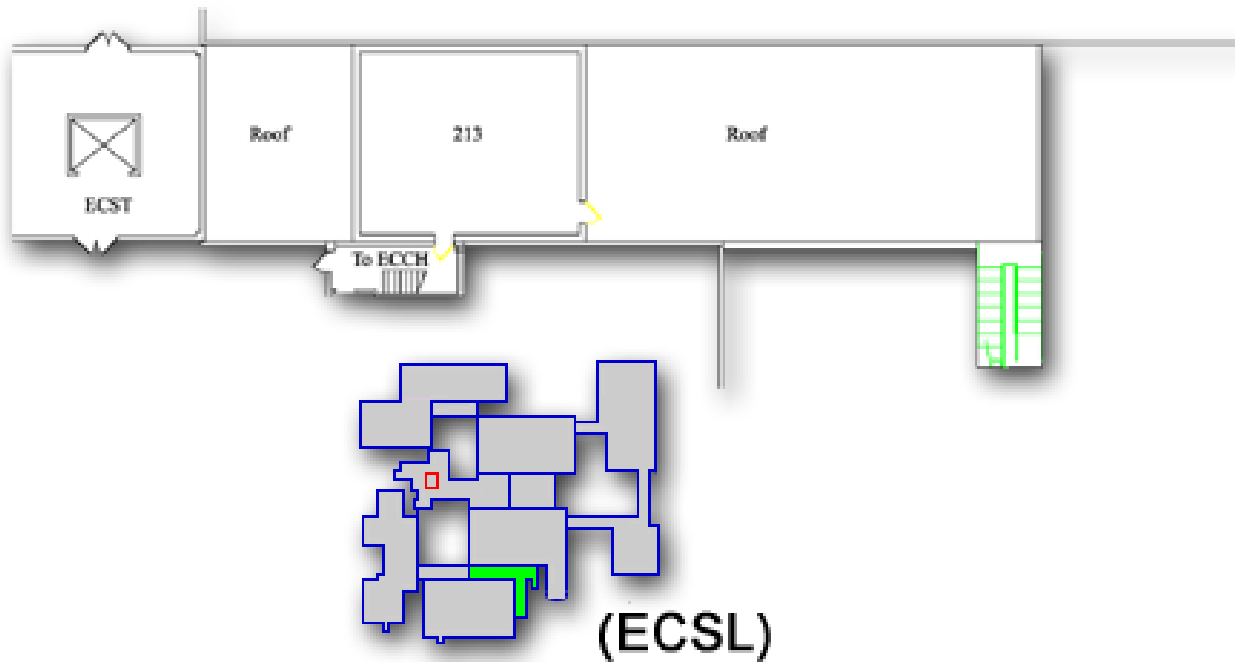

Discovery Learning Center (DLC)

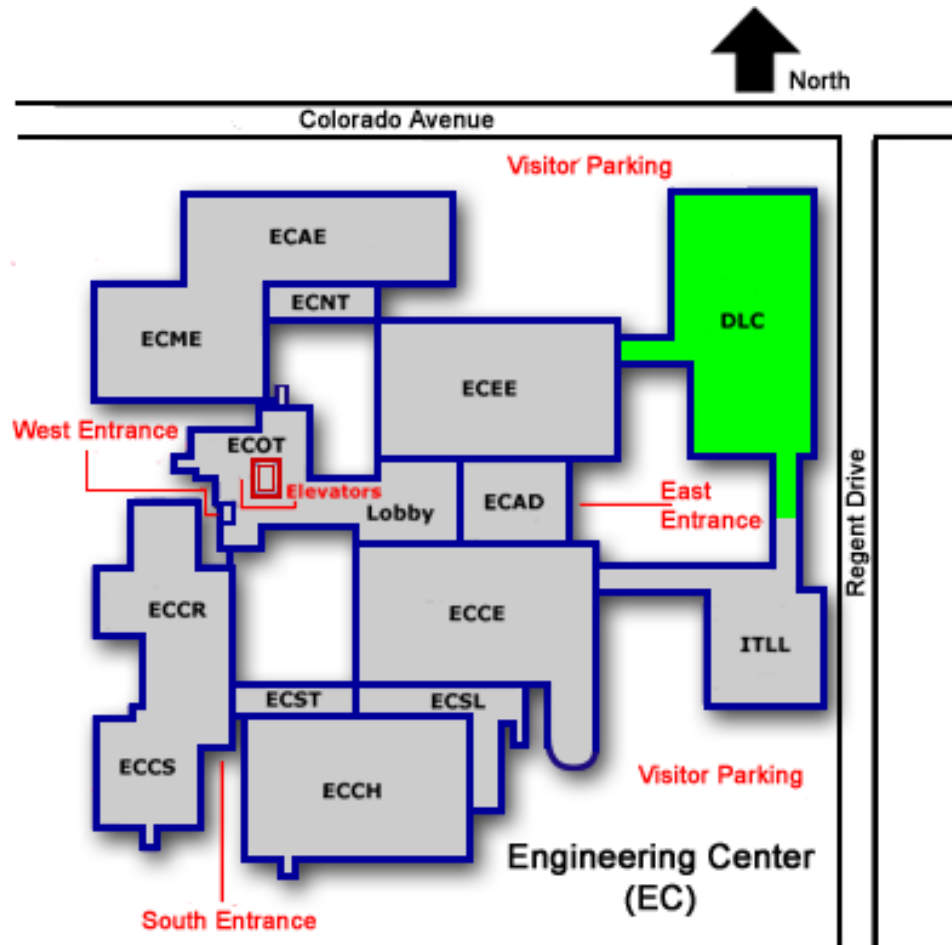

Discovery Learning Center

2nd Basement

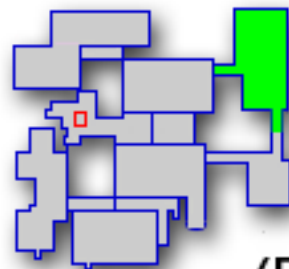
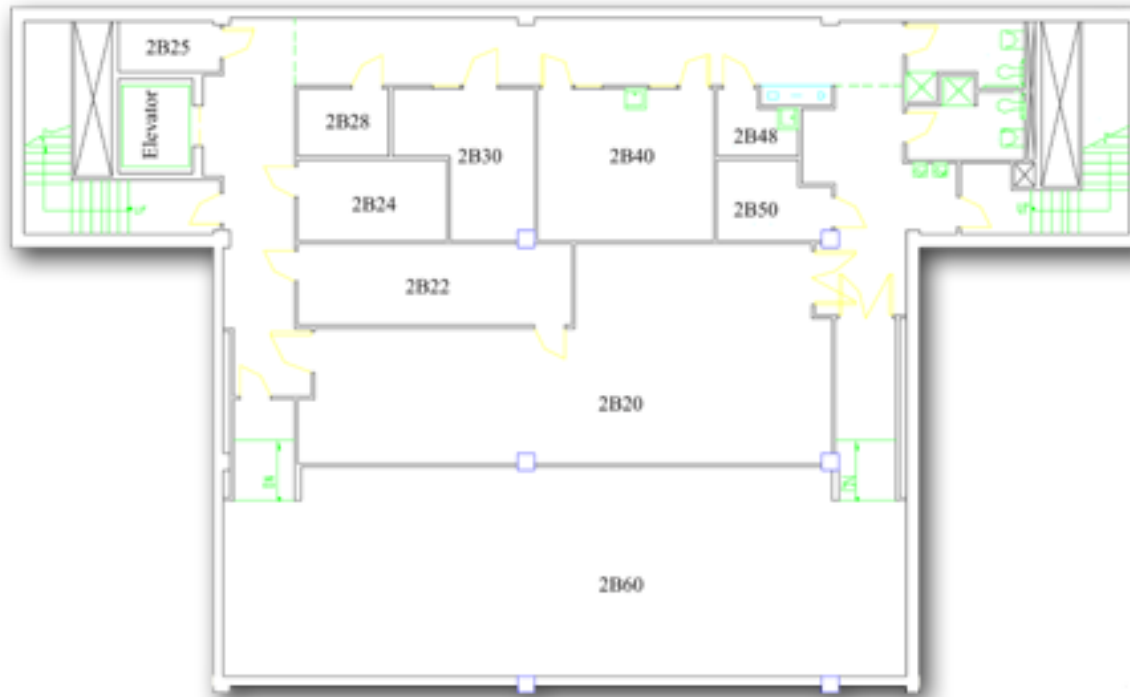

(DLC)

Discovery Learning Center

1st Basement

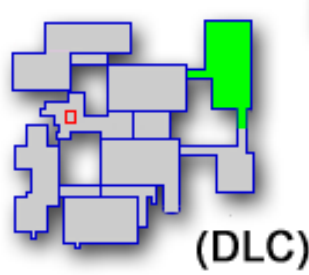

Discovery Learning Center

1st Floor

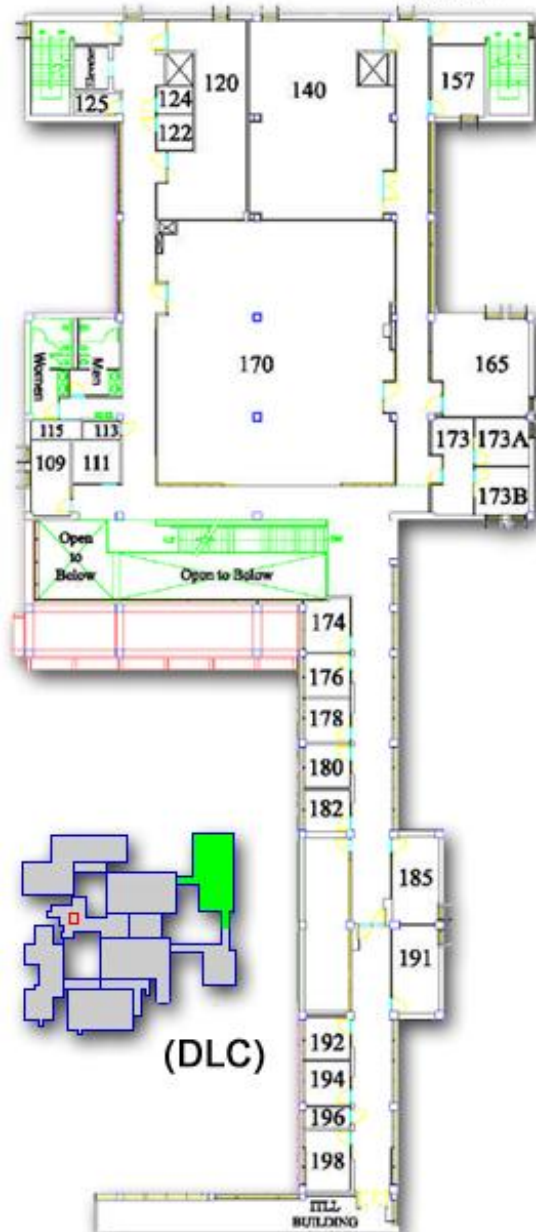

(DLC)

ITLL BUILDING

Discovery Learning Center

2nd Floor

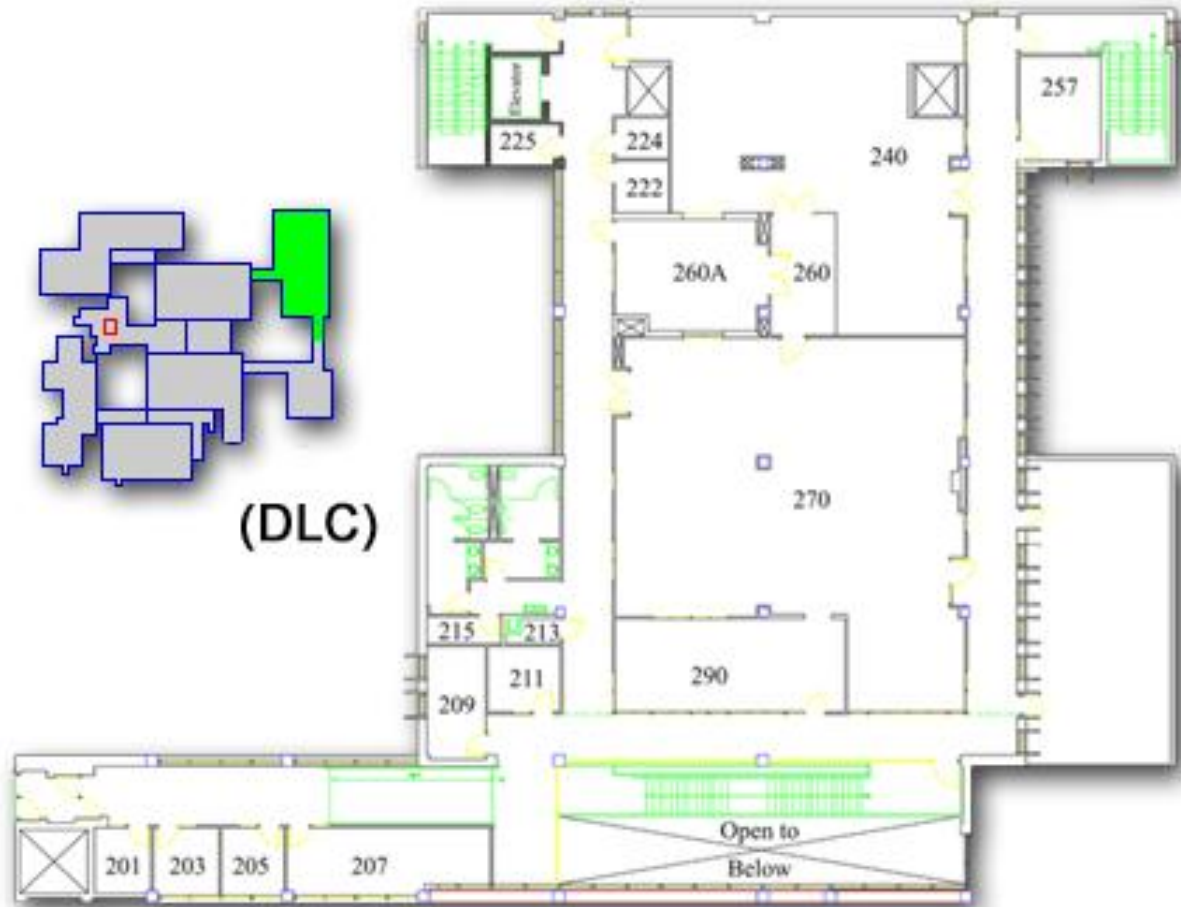

Integrated Teaching and Learning Lab (ITLL)

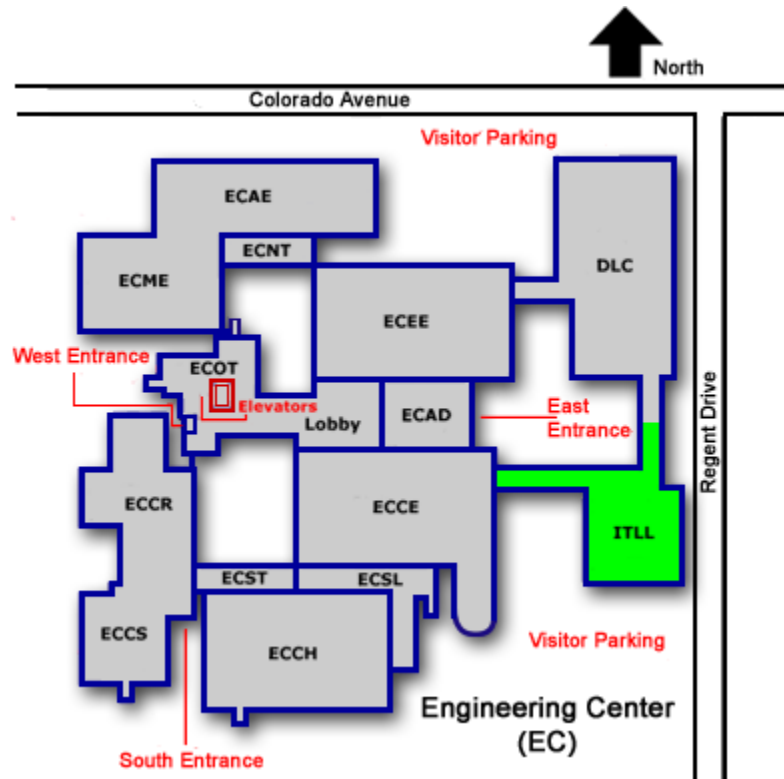

Integrated Teaching and Learning Laboratory

2nd Basement

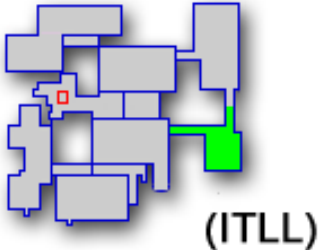
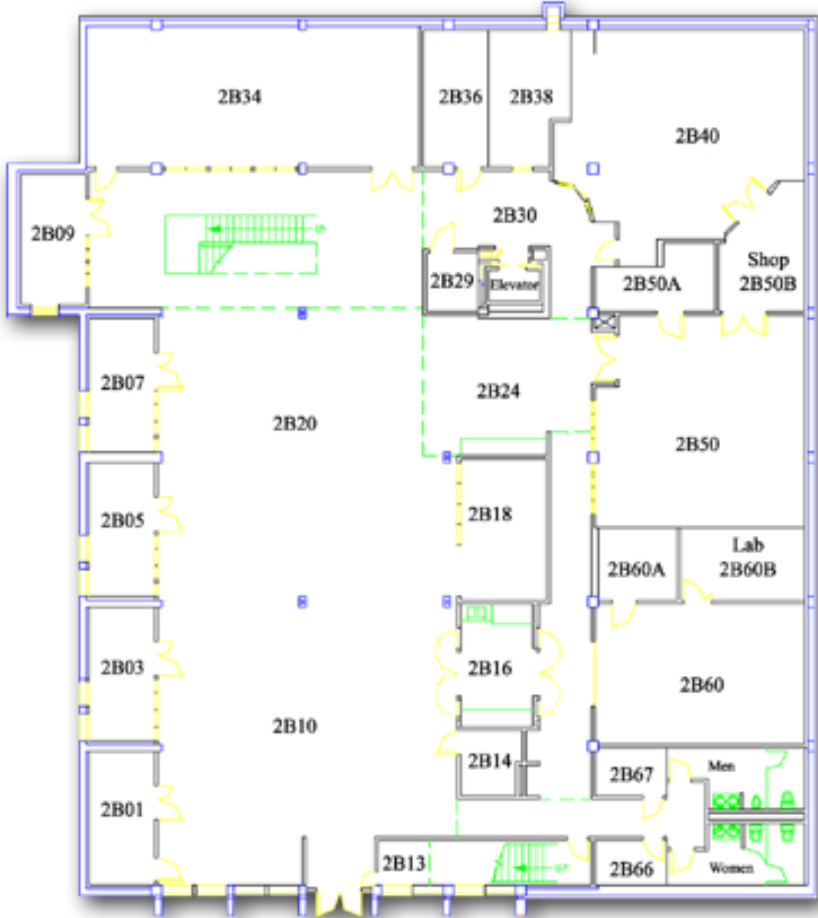

Integrated Teaching and Learning Laboratory

1st Basement

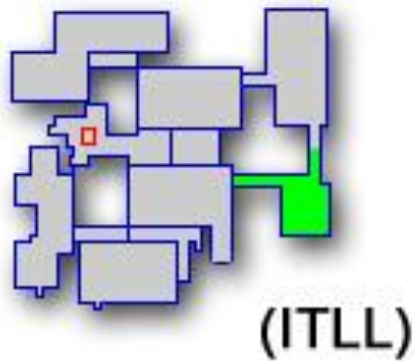
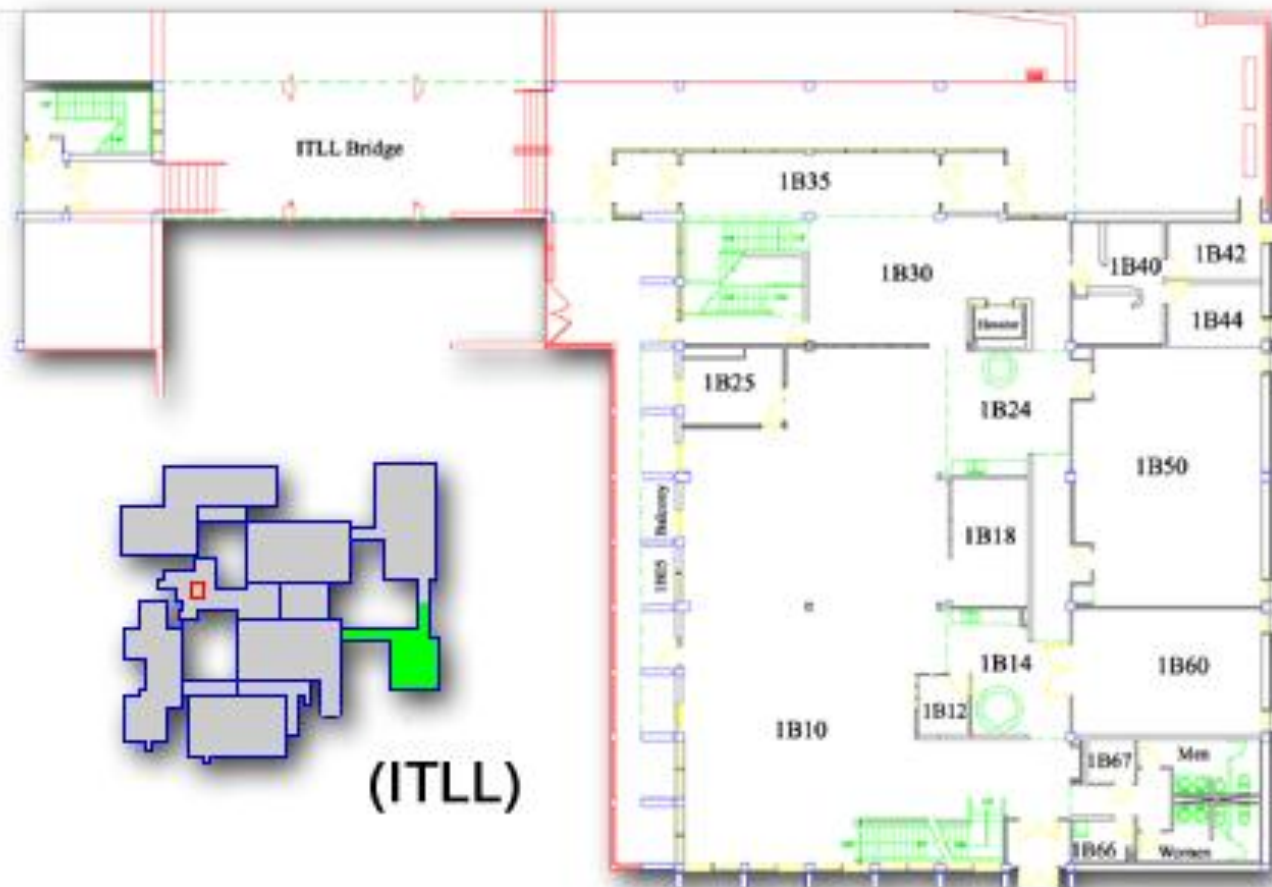

Integrated Teaching and Learning Laboratory

1st Floor

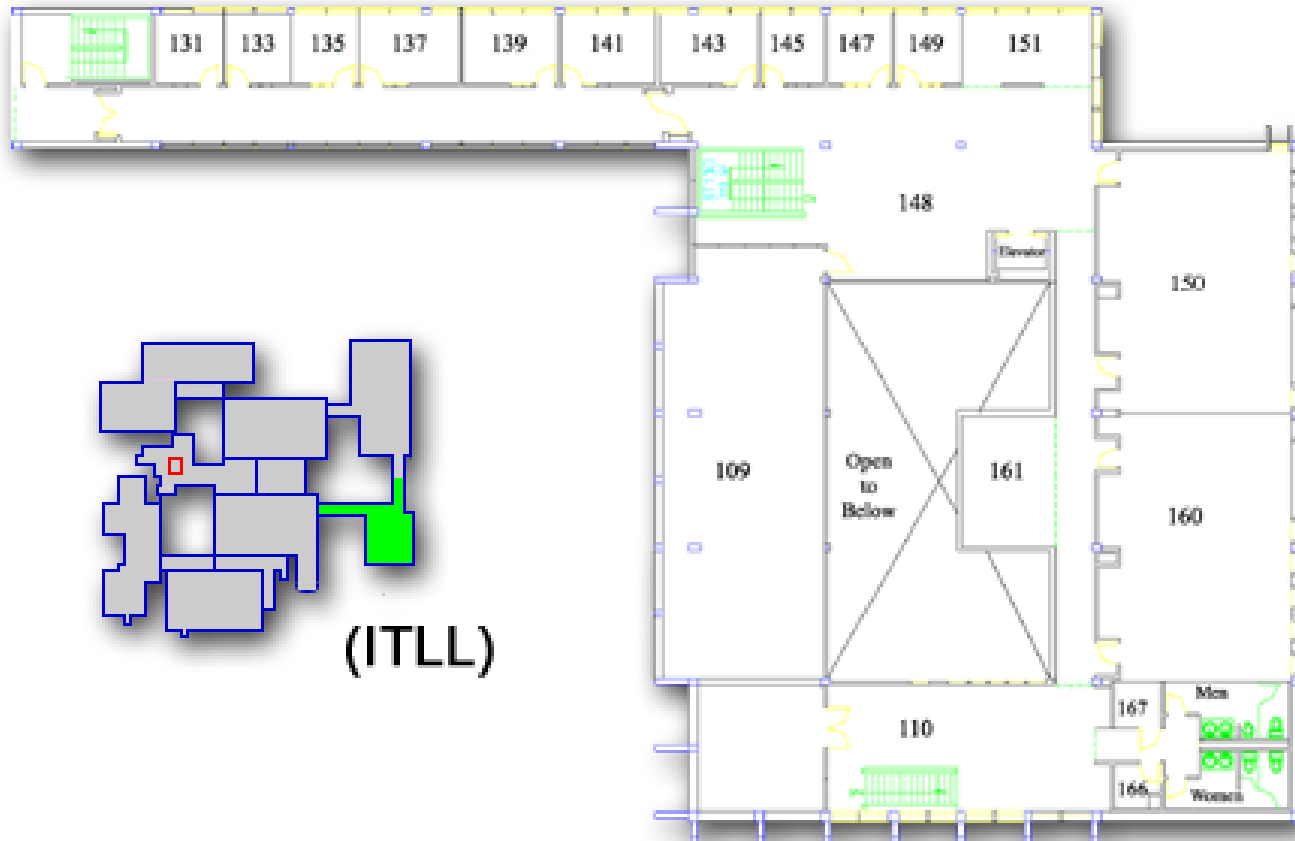

(ITLL)